



TWINFLEX[®]pro

FIRE DETECTION SYSTEM

Fire Detection & Alarm System Control Panel
(Suitable for TWINFLEX[®]pro control panels from V2.00)

Control Panel Engineering and
Commissioning Manual
(TO BE RETAINED BY THE COMMISSIONING ENGINEER)

Fike's policy is one of continual improvement and the right to change a specification at any time without notice is reserved. Whilst every care has been taken to ensure that the contents of this document are correct at time of publication, Fike shall be under no liability whatsoever in respect of such contents.

Due to the complexity and inherent importance of a life risk type system, training on this equipment is essential and commissioning should only be carried out by competent persons.

Fike cannot guarantee the operation of any equipment unless all documented instructions are complied with, without variation.

E&OE.

TWINFLEX, Multipoint, Fike and Fike Corporation are registered trademarks of Fike Corporation and its subsidiaries. All other trademarks, trade names or company names referenced herein are the property of their respective owners.

Fike equipment is protected by one or more of the following patent numbers: GB2426367, GB2370670, EP1158472, PT1035528T, GB2346758, EP0917121, GB2329056, EP0980056, GB2325018, GB2305284, EP1174835, EP0856828, GB2327752, GB2313690

© 2009 Fike Safety Technology Ltd. All rights reserved. Document revised January 2013.

Contents

Introduction.....	5
System Design.....	5
Equipment Guarantee	5
Anti Static Handling Guidelines	5
Warning	5
EMC.....	6
 The TWINFLEX[®] pro System.....	 6
 Control Panel	 7
Mounting the Control Panel	7
Physical Dimensions	7
Power Supply Unit	8
General Assembly	9
Topology and Cabling.....	9
System Wiring Schematic.....	10
Control Panel Connections	11
Overview – 4 / 8 zone panel.	11
Overview – 2 zone panel.	12
USB-B.....	12
Network: NET A, NET B, SCRN	12
Monitored Input Wiring.....	13
Programmable Inputs 1 & 2	13
Device Zones Wiring.....	14
Fault Relay.....	15
Fire Relay.....	15
Mains Input Wiring	15
Monitored Outputs 1 & 2.....	16
Auxiliary Power Output	16
Batteries.....	17
LCD Contrast	17
Write Protect / Write Enable Switch.....	18
LK1 Buzzer Link	18
8 Zone Expansion Card.....	19
 General Operation of Control Panel	 20
Control Panel Front	20
LED Indication	21
Fire Alarm Controls.....	23
System Controls	23
Access Levels and Codes	23
Access Level 1 (Normal)	24
Access Level 2A (User)	25
Access Level 2B (Supervisor)	27
Access Level 3 (Engineer).....	32
 Alarm Confirmation	 55
Introduction	55
Zone Modes	55
Instant Zones – Normal Operation in Communal Areas.	55
Delayed Zones – Confirmation Delay for Dwelling Areas.	56
Delayed Zones – Local or Zonal Alarm Confirmation.....	56

Installation and Commissioning	57
Installation 1st Stage	57
Installation 2nd Stage	57
Commissioning	58
End User Training	58
Maintenance	58
Fault Finding	59
Summary of Faults	59
Finding Zone Faults	61
Advanced Connections	62
Magnetic Door Hold Units	62
Connecting Two Panels Together	63
Connecting Four Panels Together	64
Connecting Two TF Pro Panels & one TF V3 Panel Together	65
Peripheral Buss Connections	66
Peripheral Buss Settings	67
Technical Data	68
Control Panel Specification	68
Control Panel Ratings	68
Control Panel Fuses	68
Battery Calculations	69
Installation Checklist	71
Commissioning Checklist	72
Cable Continuity and Insulation Test Results	73
Fire Alarm System Notice	74
Fire Alarm User Notice	75
Engineers Notes	76

Introduction

This Manual is intended as a guide to the engineering and commissioning principles of the TWINFLEX[®] pro 2-wire Fire Detection and Alarm system and covers the system hardware information only.

Due to the complexity and inherent importance of a system covering a 'Life Protection Risk', training on this equipment is essential and commissioning should only be carried out by competent and approved persons. For further details of the availability of commissioning services, please contact your supplier.

System Design



This document does not cover Fire Alarm system design and a basic understanding is assumed.

A knowledge of BS5839: Pt 1: 2002: Fire Detection and Alarm Systems for Buildings is essential.

It is strongly recommended that a suitably qualified and competent person is consulted in connection with the Fire Alarm System design and that the entire system is commissioned in accordance with the current national standards and specifications.

Equipment Guarantee



The equipment carries no warranty unless the system is installed, commissioned and serviced in accordance with this manual and the relevant standards by a suitably qualified and competent person or organisation

Anti Static Handling Guidelines



Immediately prior to handling any PCBs or other static sensitive devices, it is essential to ensure that a personal **connection to earth is made with an anti-static wrist-strap** or similar apparatus.

Always handle PCBs by their sides and avoid touching any components. PCBs should also be stored in a clean dry place, which is free from vibration, dust and excessive heat and is protected from mechanical damage.

Warning



Do not attempt to install this equipment until you have fully read and understood this manual.

Failure to do so may result in damage to the equipment and could invalidate the warranty.

For technical support please contact your distributor. Do not call the Fike Safety Technology support department unless your distributor has first given their advice and attempted to rectify the issue.

Technical support will **not** be available if the instruction manual has not been read and understood. Please have this instruction manual available whenever you call for technical support.

EMC



This equipment when installed is subject to the EMC directive 2004/108/EC. It is also subject to UK Statutory Instrument 2006 No. 3418.

To maintain EMC compliance, this system must be installed as defined within this manual. Any deviation from this renders the installer liable for any EMC problems that may occur either to the equipment or to any other equipment affected by the installation.

The TWINFLEX[®] pro System

The TWINFLEX[®] pro system is an intelligent '2-wire' system utilising a conventional type cabling format. The system is classed as 'Analogue non-addressable' due to the architecture used within the design. All field devices including sounders can be connected to the zone via a common 2-core screened cable. The devices communicate with the control panel using the 'TWINFLEX[®]' data protocol.

The TWINFLEX[®] pro panel monitors each zone for detector head removal, device fault, 'End of line' fault and open or short circuit fault.

Devices or detector heads should not be removed with the zone switched on. Switch off the zone (at access level 3) before removing any devices or detector heads from that zone.

Detector heads must only be removed using the correct head removal tool, 25-0046-201 for ASD heads & 25-0015-301 for old style heads. Removing detector heads without using the correct tool will result in damage to the head / detector base.

Every device has an inbuilt 'End of line' signal, which may be activated as required. All setting options are configured using the DIL switches fitted to the device.

Do not use a resistor or Capacitor or any other 3rd party 'End of line' module for 'End of line'.

The TWINFLEX[®] pro control panel also provides two monitored outputs that may be configured as conventional sounder circuits or conventional 24V monitored relay circuits, a volt free common fire relay and a volt free common fault relay. There are also two multifunction latching/non-latching inputs and one monitored input programmable with options such as 'Class-Change' and 'Remote fire input'.

The TWINFLEX[®] pro control panel incorporates an integral power supply unit and requires **2 x 12V 3.2Ah (or 3.3Ah) batteries** to provide up to 72 hour standby times depending on system loading (refer to Technical Data for further information). Standby battery calculations may be made using the TWINFLEX[®] pro Panel Battery & Loading Unit Calculation Sheet (document no. 26-1116).

Unlike most conventional fire alarm systems, which require separate pairs of cables for detector zones and sounder circuits, the TWINFLEX[®] pro system requires one 2-core screened cable for each zone to accommodate both detection devices and sounders. Furthermore, sounders are incorporated within the detector to reduce system components and simplify installation.

The TWINFLEX[®] pro panels include some features described in EN54-2 as 'optional functions with requirements'. These are:-

Output to fire alarm devices	EN54-2 Clause 7.8
Output to fire protection equipment, type A	EN54-2 Clause 7.10.1
Dependency on more than one alarm signal, type A (Confirmation)	EN54-2 Clause 7.12.1
Delays to outputs	EN54-2 Clause 7.11.1
Zone test facility	EN54-2 Clause 10
Input/output facilities	

These facilities are described elsewhere in this manual.

Control Panel

Mounting the Control Panel

First identify the proposed location for the control panel. Ensure that the control panel will be easily accessible and that account is taken of any subsequent work that may affect access.

The control panel should be located at the most likely point of access for the fire services. It should be mounted on a flat, vertical wall at a height where the indicators may be seen without difficulty.

Do not locate the control panel at high level where stepladders or other access equipment may be required, in spaces with restricted access, or in a position that may require access panels to be removed.

Do not locate the control panel where extremes of temperature or humidity may occur, or where there is any possibility of condensation or water ingress.

Like all electronic equipment, the control panel may be affected by extreme environmental conditions. The position selected for its installation should therefore be clean and dry, not subjected to high levels of vibration or shock and at least 2 metres away from any pager or radio transmitting equipment. Ambient temperatures should be within the range given within the Technical Data section, e.g. not directly over a radiator or heater.

In common with all microprocessor-controlled panels, the control panel may operate erratically or may be damaged if subjected to lightning induced transients. Proper earth/ground connections will greatly reduce susceptibility to this problem.

Physical Dimensions

All Panels

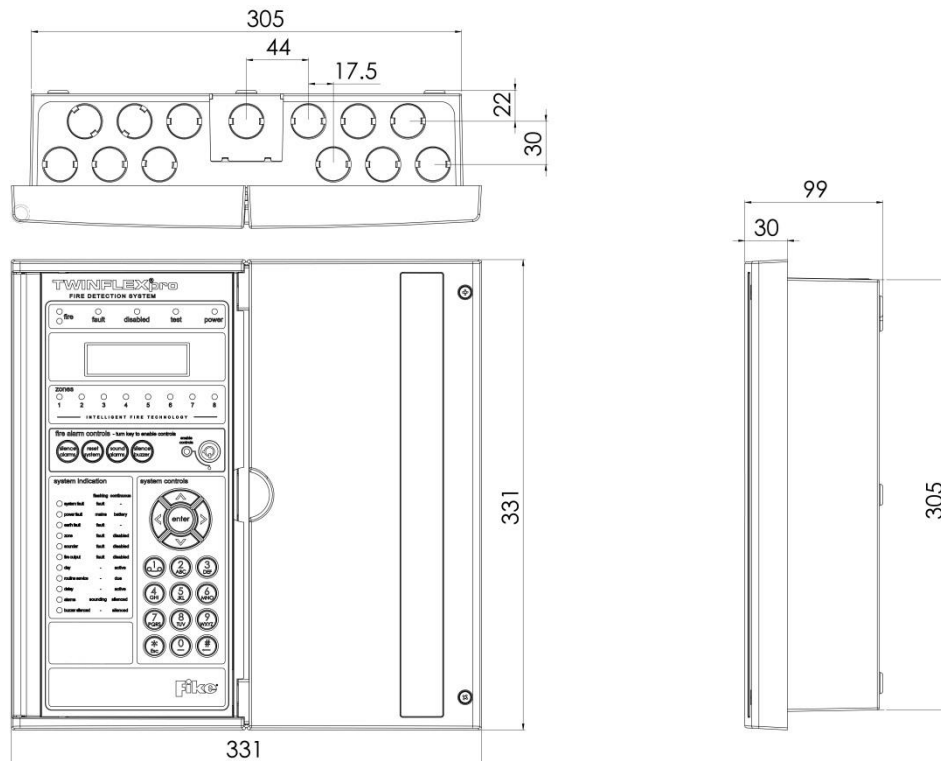

Power Supply Unit

The mains supply should be dedicated to the Fire Alarm Panel and should be clearly labelled 'FIRE ALARM: DO NOT SWITCH OFF' at all isolation points. The Fire Alarm Panel 230V AC supply requires a 3 amp fused un-switched spur with local isolation and fixed wiring between 0.75 mm² and 2.5 mm², terminated into the fused terminals provided in the back box. The main PCB is supplied via a Switch Mode Power Supply located below the vented cover. Only the power supply provided in the unit may be used to power the control panel. Both mains termination and location of power supply are shown below.

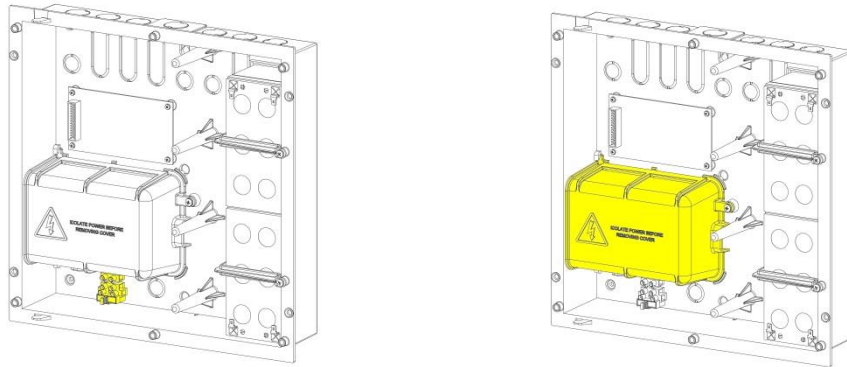

The control panel requires standby batteries and **2 x 12V 3.2Ah (or 3.3Ah)** sealed lead acid batteries should be installed according to the following diagram. These are to be sited in the control panel back box using the provided clamps. The batteries should be connected in series using the connection leads supplied. See the section entitled *Control Panel Connections* for panel connections.

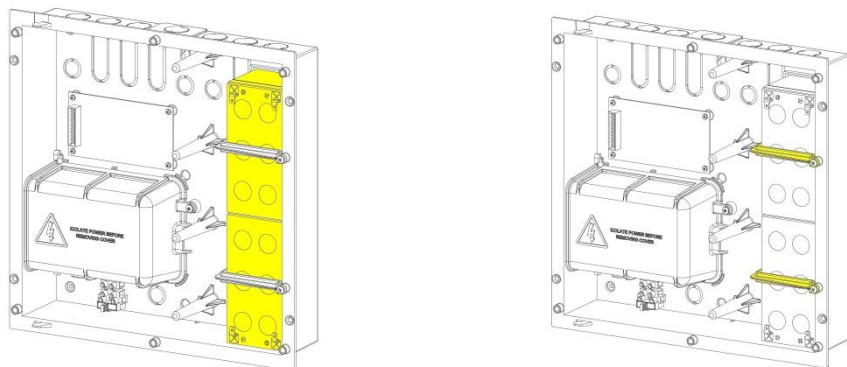

Note that the charging circuit will be in its high impedance state (approximately 3V DC) if no batteries, faulty batteries, or only one battery is connected. The full 27V DC (nominal) charging voltage should be present if the correct batteries are connected.

If the system shows a charger or battery fault on first power up, leave the system to charge the batteries for 5-6 hours.

In order to test for correct operation of the batteries, remove the mains 230V AC fuse and allow the batteries to settle from their charging voltage for approximately 5 minutes. The battery voltage should then be measured using an electronic test meter and a voltage greater than 24V DC should be seen.

Note that batteries are electrically live at all times and great care should be taken to ensure that the terminals are never presented with a short circuit. Care should be taken at all times, especially during transit, installation and normal use.

Batteries no longer required should be disposed of in a safe and environmentally friendly manner by the manufacturer or a suitable recycling service. They should never be incinerated or placed in normal rubbish collection facilities.

General Assembly

All Panels

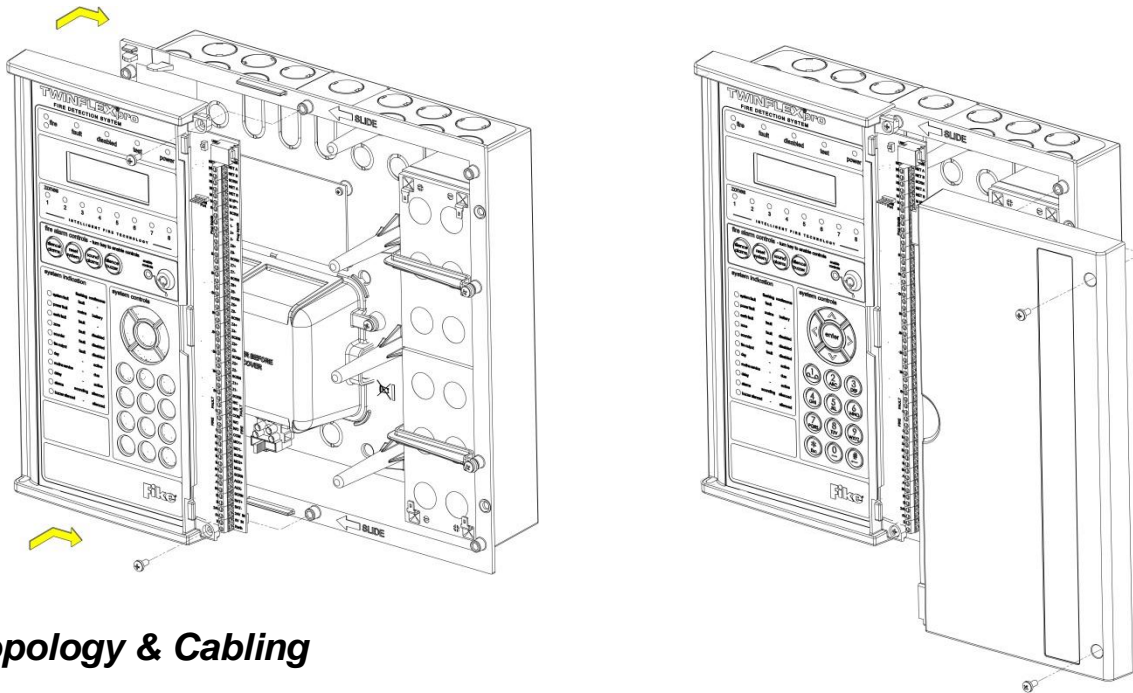

Topology & Cabling

All system wiring should be installed to comply with BS 5839: Pt 1: 2002 and BS 7671 (wiring regulations) and any other standards relevant to the area or type of installation. A cable complying with the BS 5839: Pt 1: 2002 Category 1 (cables required to operate for prolonged periods during fire conditions) is required. This must be a 2-core 1.5mm² screened fire resistant cable (ie. MICC, FP200, Firetuff, Firecell, Lifeline or equivalent).

Each zone requires a separate 2-core radial circuit from the control panel to the furthest point of the zone, to a maximum of 500 metres.

In order to protect against possible data corruption it is important to ensure the following points are adhered to:

1. The cable **screen must be connected to earth/ground at the control panel** only.
2. The cable screen must not be connected to earth/ground at any point other than the control panel (at the SCRN terminal provided, not at any earthing point). **Do not connect the screen to a device back box.**
3. The cable **screen continuity must be maintained** at every point of the circuit, using the terminals provided or a suitable connection block.
4. **Do not** use a 4-core cable as a circuit **zone in** and **zone out**, due to the possibility of data corruption. It is essential that two 2-core screened cables are used if this is required.

Refer to the following System Wiring Schematic for further details.

System Wiring Schematic

The following schematic may prove useful as an aid to understanding the cable requirements for the system;

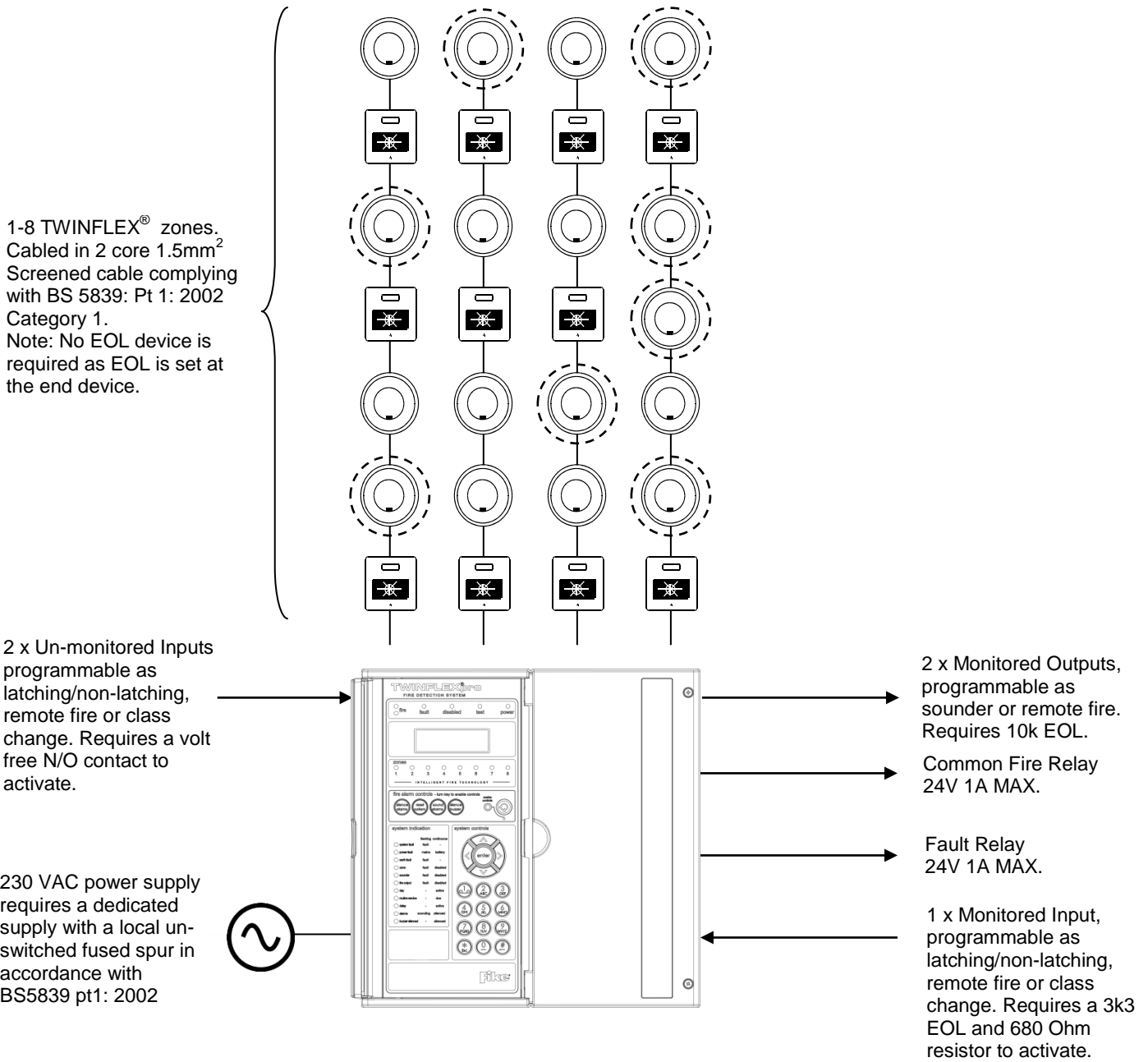

KEY TO SYMBOLS



TWINFLEX® Multipoint

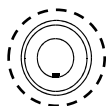

TWINFLEX® Multipoint with Sounder



TWINFLEX® Manual Call Point

Control Panel Connections

Overview – 4 / 8 zone Panel

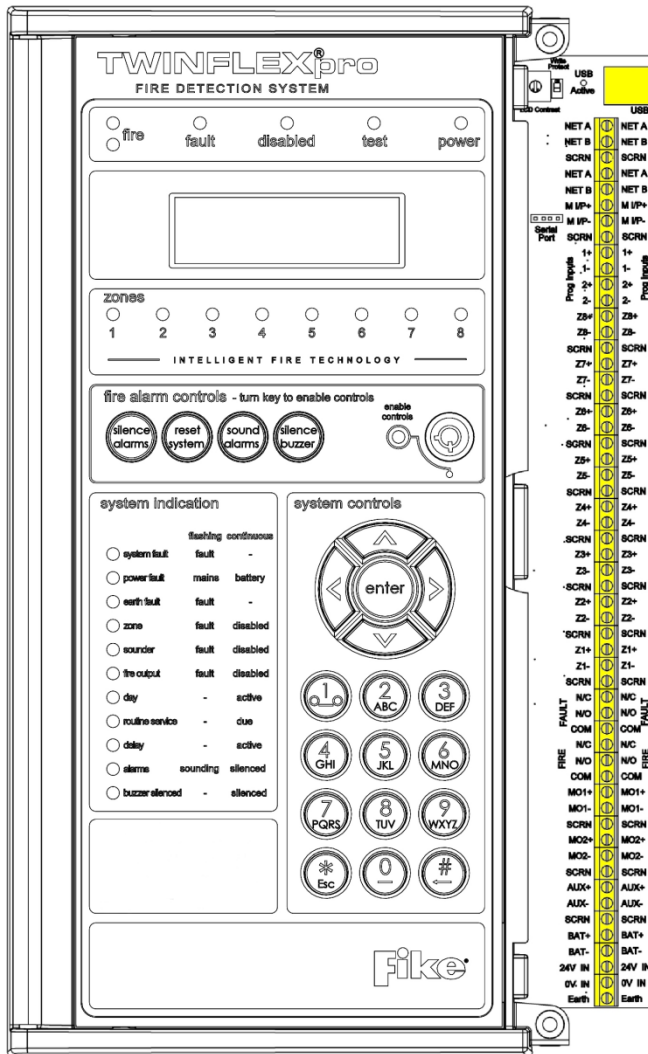

The above diagram shows the terminals for the 4 zone / 8 zone version of the TWINFLEX[®] pro panel.

TERMINAL	DESCRIPTION
USB	
USB-B	USB-B CONNECTION FOR PC LINK
NETWORK	
NET A	RESERVED FOR FUTURE NETWORKING
NET B	RESERVED FOR FUTURE NETWORKING
SCRN	RESERVED FOR FUTURE NETWORKING
NET A	RESERVED FOR FUTURE NETWORKING
NET B	RESERVED FOR FUTURE NETWORKING
SCRN	RESERVED FOR FUTURE NETWORKING
MONITORED I/P	
MI1 +	Monitored Input positive connection
MI1 -	Monitored Input 0V connection
SCRN	Field cable screen connection
PROG I/P 1+2	
+	Programmable Input positive connection
-	Programmable Input 0V connection
ZONES 1 - 8	
Z +	Device zone positive connection
Z -	Device zone 0V connection
SCRN	Field cable screen connection
FAULT RELAY	
N/C	Normally closed fault contact
N/O	Normally open fault contact
COM	Common fault contact
FIRE RELAY	
N/C	Normally closed fire contact
N/O	Normally open fire contact
COM	Common fire contact
MONITORED O/P 1+2	
MO +	Monitored Output positive connection
MO -	Monitored Output 0V connection
SCRN	Field cable screen connection
AUX SUPPLY	
AUX +	Aux power positive connection
AUX -	Aux Power 0V connection
SCRN	Field cable screen connection
BATTERY	
BATT +	24V DC 3.3Ah Battery positive connection
BATT -	24V DC 3.3Ah Battery 0V connection
PSU	
24V IN	24V DC Input from Switch Mode PSU
0V IN	0V DC Input from Switch Mode PSU
SCRN	Earth input from Switch Mode PSU

Note: References to voltages are nominal values, batteries may be 3.2Ah

Overview- 2 zone panel

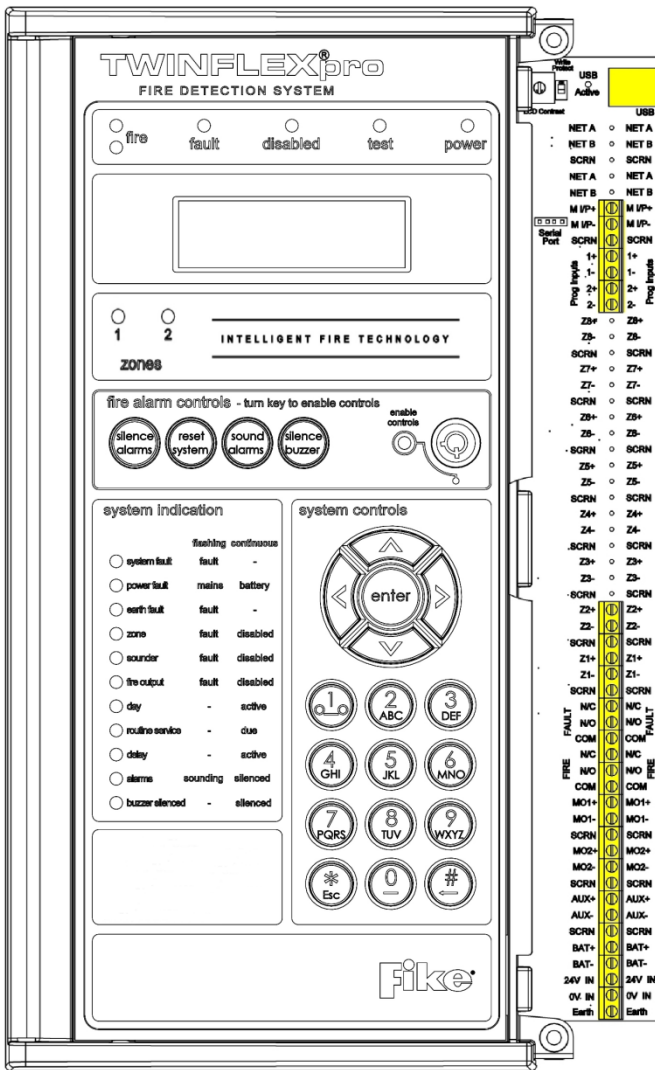

The above diagram shows the terminals for the 2 zone version of the TWINFLEX[®] pro panel.

TERMINAL	DESCRIPTION
USB	
USB-B	USB-B CONNECTION FOR PC LINK
MONITORED I/P	
MI1 +	Monitored Input positive connection
MI1 -	Monitored Input 0V connection
SCRN	Field cable screen connection
PROG I/P 1+2	
+	Programmable Input positive connection
-	Programmable Input 0V connection
ZONES 1 - 2	
Z +	Device zone positive connection
Z -	Device zone 0V connection
SCRN	Field cable screen connection
FAULT RELAY	
N/C	Normally closed fault contact
N/O	Normally open fault contact
COM	Common fault contact
FIRE RELAY	
N/C	Normally closed fire contact
N/O	Normally open fire contact
COM	Common fire contact
MONITORED O/P 1+2	
MO +	Monitored Output positive connection
MO -	Monitored Output 0V connection
SCRN	Field cable screen connection
AUX SUPPLY	
AUX +	Aux power positive connection
AUX -	Aux Power 0V connection
SCRN	Field cable screen connection
BATTERY	
BATT +	24V DC 3.3Ah Battery positive connection
BATT -	24V DC 3.3Ah Battery 0V connection
PSU	
24V IN	24V DC Input from Switch Mode PSU
0V IN	0V DC Input from Switch Mode PSU
SCRN	Earth input from Switch Mode PSU

Note: References to voltages are nominal values, batteries may be 3.2Ah

USB-B

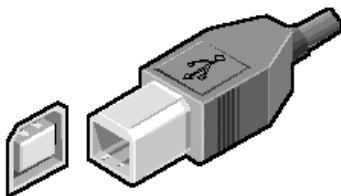

The panel is fitted with an onboard USB-B connector. This is to provide communication via a suitable USB lead to a PC for programming of panel options using the TWINFLEX[®] pro OSP configuration software.

Network: NET A, NET B, SCRIN

NET A & B is an RS485 buss and can communicate with up to 8 Twinflex repeater panels.

Note: Repeaters can only be used on 4 & 8 zone panels. Repeaters will not work on 2 zone panels. Refer to Advanced Connections for network connections (Peripheral Buss connections) on pages 64 & 65.

Monitored Input: MI1+, MI1-, SCRIN

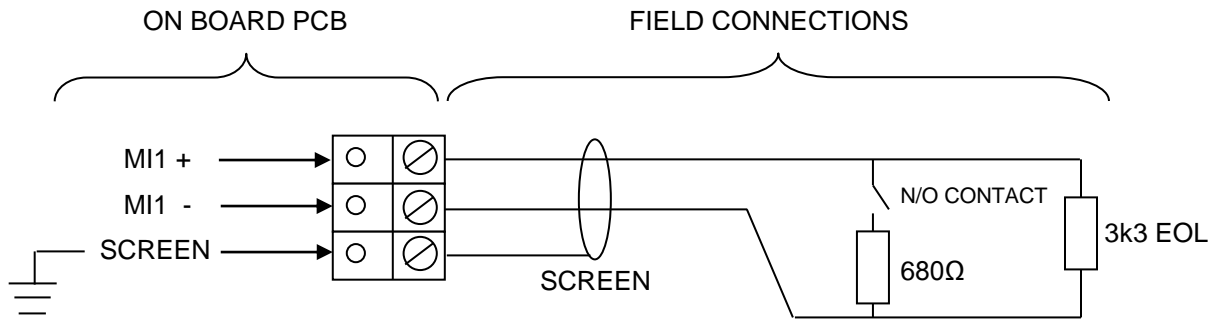

Maximum Voltage at contacts, 3.3 Volts. Maximum current 10mA.

Monitored Input 1 may be configured to monitor for open and short circuit faults using a 3k3 EOL resistor and to activate an alarm using a 680Ω 'firing' resistor. It may be configured from the engineer menu to the following options:

CONTROL EVENT	SILENCE ALARMS	DISABLEMENT	DISABLE SOUNDERS
	RESET SYSTEM		DISABLE REM FIRE
REMOTE FIRE EVENT	SOUND ALARMS	DISABLE INPUT	DISABLE SNDR/REM FIRE
	SILENCE BUZZER		INPUT ON
TECHNICAL EVENT	REMOTE FIRE - FULL		INPUT OFF
	REM FIRE, NO RELAY		
	LATCH		
	NON-LATCH		

Monitored Input 1 is an ancillary function and is not required by EN 54-2.

Programmable Inputs 1 and 2:

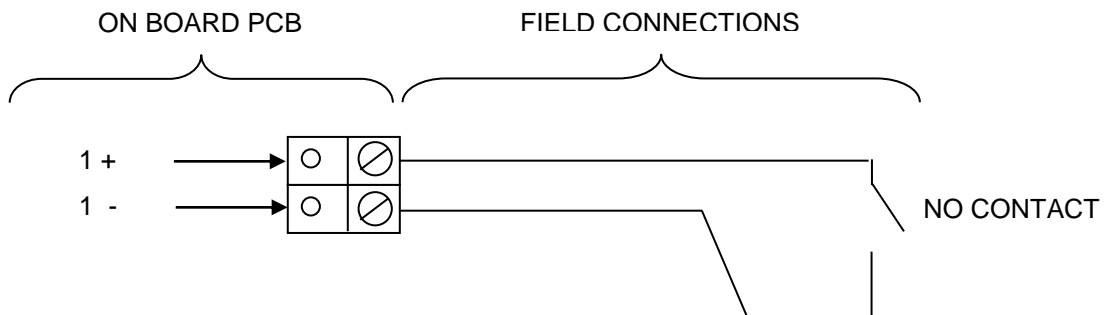

Maximum Voltage at contacts, 3.3 Volts. Maximum current 10mA.

Inputs 1-2 are Un-monitored and require a normally open contact to operate. They may be configured from the engineer menu to the following options:

CONTROL EVENT	SILENCE ALARMS	DISABLEMENT	DISABLE SOUNDERS
	RESET SYSTEM		DISABLE REM FIRE
REMOTE FIRE EVENT	SOUND ALARMS	DISABLE INPUT	DISABLE SNDR/REM FIRE
	SILENCE BUZZER		INPUT ON
TECHNICAL EVENT	REMOTE FIRE - FULL		INPUT OFF
	REM FIRE, NO RELAY		
	LATCH		
	NON-LATCH		

Programmable Inputs 1 & 2 are ancillary functions and are not required by EN 54-2

Caution – the use of an input to disable the buzzer does not meet EN54-2

Device Zones: Z1 - Z8:

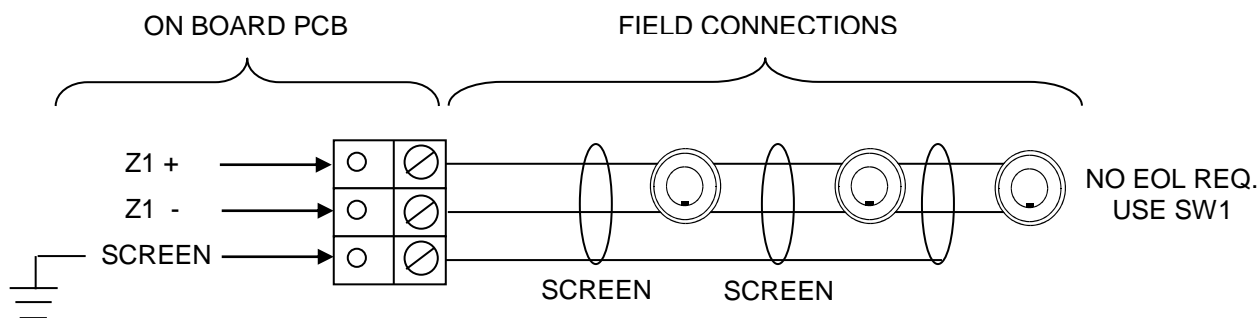

Each zone requires a separate 2-core radial circuit from the control panel to the furthest point of the zone, to a maximum of 500 metres.

In order to protect against possible data corruption it is important to ensure the following points are adhered to:

1. The cable **screen must be connected to the SCR N terminal at the control panel only**.
2. The cable screen must not be connected to earth/ground at any point other than the control panel (at the SCR N terminal provided, not at any earthing point). **Do not connect the screen to any device back box used other than those supplied by Fike.**
3. The cable **screen continuity must be maintained** at every point of the circuit, using the terminals provided or a suitable connection block.
4. **Do not** use a 4-core cable as a circuit **zone in** and **zone out**, due to the possibility of data corruption. It is essential that two 2-core screened cables are used if this is required.

No EOL resistor or unit should be fitted to terminate the cable, this function is performed via DIL switch 1 on the last device.

If a zone is **NOT** used it **MUST** be switched off using the zone status menu in the engineers programming options.

MAXIMUM NUMBER OF DEVICES PER ZONE

Must not exceed 32 devices dependant on Device Loading Units (DLUs) not exceeding the stated maximum loading. To ensure the maximum loading is not exceeded, use the TWINFLEX[®] pro Panel Battery & Loading Unit Calculation Sheet (document no. 26-1116).

Fault Relay: C, N/C, N/O

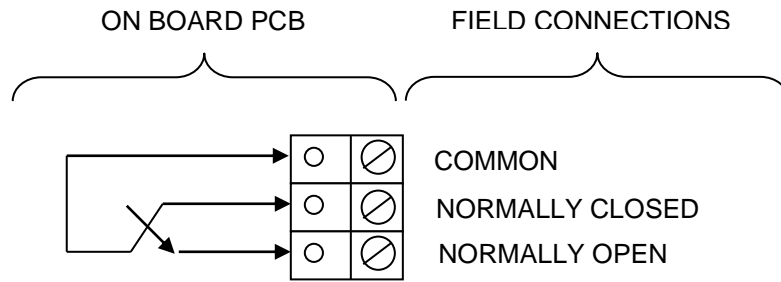

The fault relay is derived from a single pole change over 'volt-free' relay contact which is not fault monitored. The fault relay output is rated at 30V DC 200mA max. Inductive loads should be diode protected (eg. using a 1N4004 diode) to prevent back EMF causing damage to the relay contact.

The default setting for the fault relay causes the relay to operate as a **Common Fault** output where the relay is de-energised in the fault condition and will remain so until the fault is cleared.

Fire Relay: C, N/C, N/O

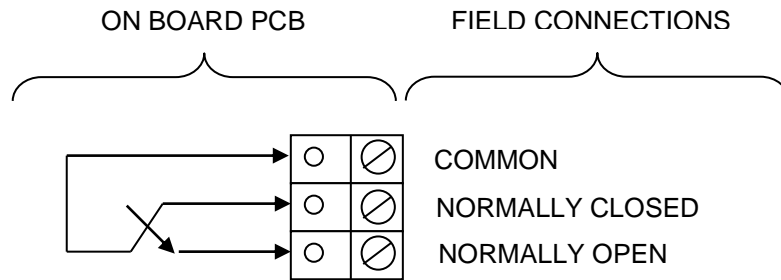

The fire relay is derived from a single pole change over 'volt-free' relay contact which is not fault monitored. The fire relay output is rated at 30V DC 200mA max. Inductive loads should be diode protected (eg. using a 1N4004 diode) to prevent back EMF causing damage to the relay contact.

The default setting for the fire relay causes the relay to operate as a **Common Fire** output where the relay is energised in the fire condition and will remain so until the system is reset.

Mains Input Wiring

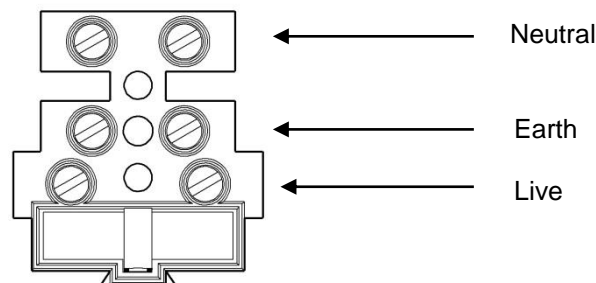

Fuse T4A Ceramic

Monitored Outputs 1 and 2: MO+, MO-, SCR N

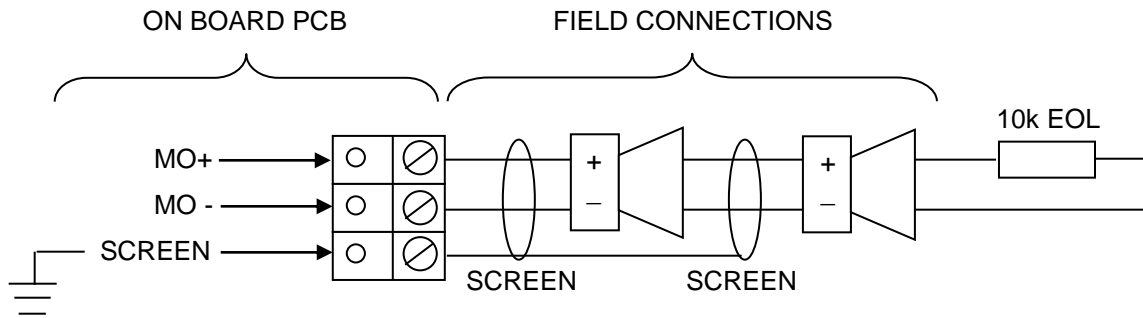

Outputs 1 and 2 are monitored circuits which may be configured to monitor for open and short circuit faults with a 10k EOL resistor.

The default setting for outputs 1 and 2 cause the circuits to operate as **Common Fire Sounder Circuits**, where the outputs step up to nominally 28V DC in the alarm condition. Various other states listed below may also be set from the engineers menu. The maximum output current for each output is **250mA** for a 2 – 4 zone panel, **200mA** for an 8 zone panel. These outputs are protected by the **F315mA** fuses.

OUTPUT TYPE	REMOTE SOUNDER
	REMOTE FIRE
	OFF

Auxiliary Power: AUX+, AUX-, SCR N

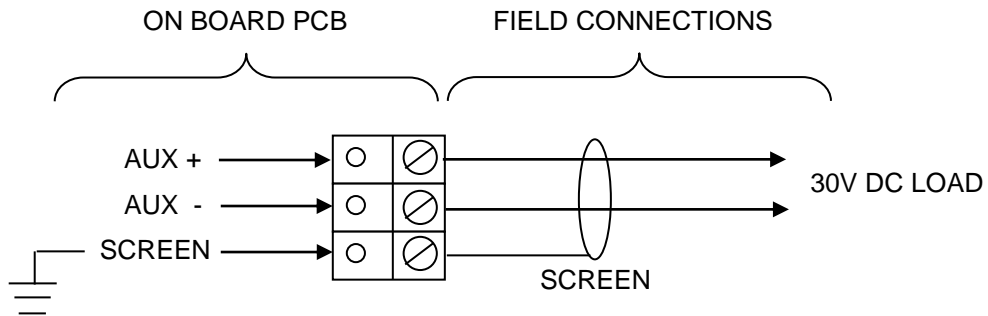

An auxiliary nominal 24V DC power supply is available to power ancillary devices requiring up to 30V DC.

Note: The auxiliary power supply output will be approximately 30-31V DC when the panel is running from a mains supply and between 22 and 27V when running from the batteries in a mains failure condition.

The maximum output current is **250mA**. The Auxiliary Power is protected by an **F315mA** fuse.

It is suggested that additional Power Supply Units be installed to provide power for additional loads.

Battery: BAT+, BAT-

Terminals are supplied to connect and charge standby batteries. The charging circuit has been designed to charge 2 x 12V DC 3.2Ah or 3.3Ah sealed lead acid batteries. Batteries should be connected in series as per the diagram.

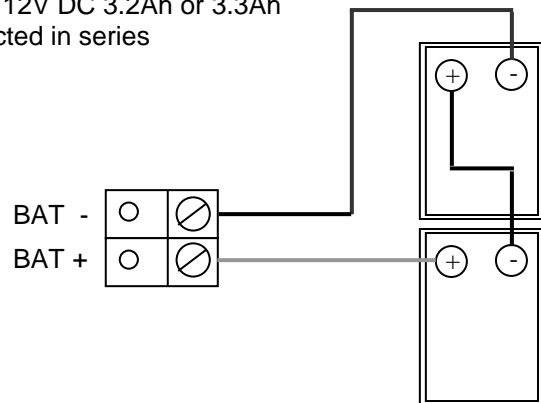

LCD Contrast

Note : 4 Zone / 8 Zone Panel version shown

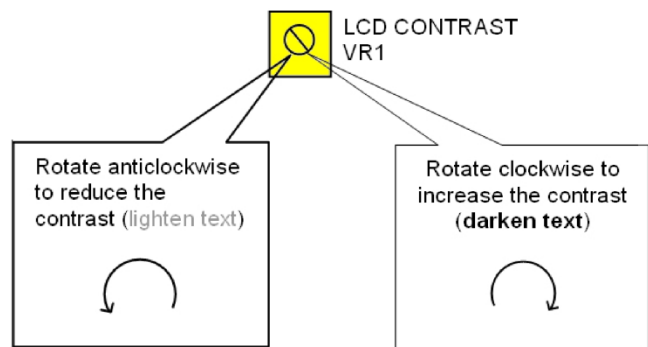
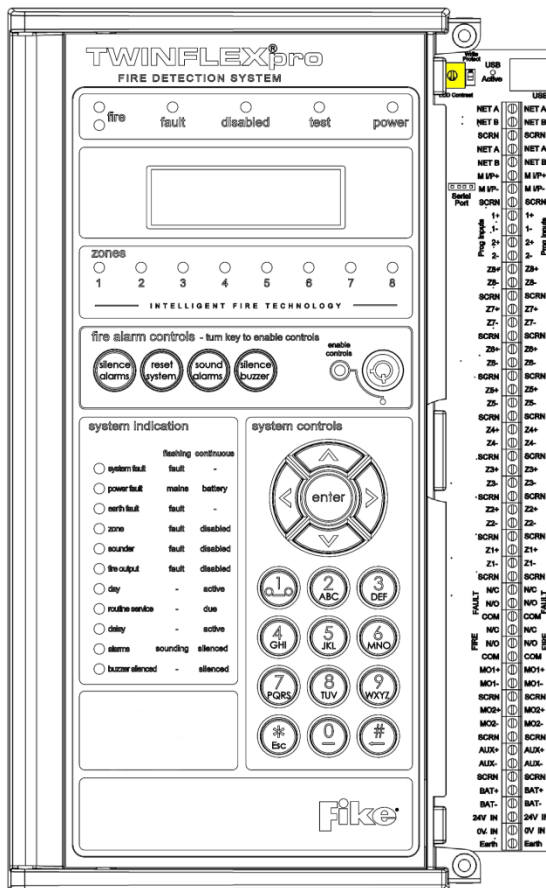

The LCD contrast may be adjusted by rotating the screw on the variable resistor, located in the upper right hand corner of the main PCB.

Write Protect / Write Enable Switch

Note : 4 Zone / 8 Zone Panel version shown

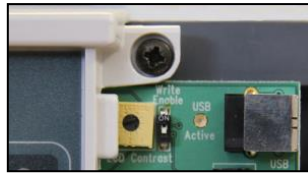
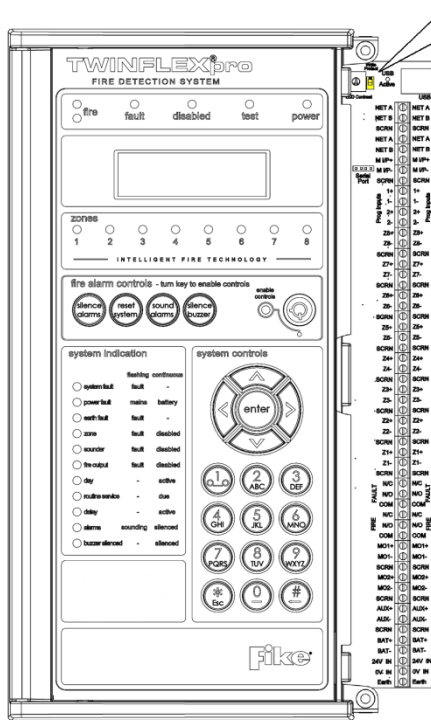

The write protect / write enable switch is a two position switch which is normally set to stop options in the engineer menu from being inadvertently changed.

<p>Switch in OFF position</p>	<p>Write Protect Mode:</p> <p>In the OFF position, as shown (left), engineering options may be viewed but no changes made.</p>
<p>Switch in ON position</p>	<p>Write Enable Mode:</p> <p>If changes are to be made, this switch needs to be in the ON position as shown (left).</p> <p>If the switch is left ON whilst the panel is not in engineer mode a system fault will be reported.</p>

LK1 Buzzer Link

Linking out LK1 will disable the panel buzzer. The buzzer will remain disabled whilst the link is in place. **Warning – To comply with EN54 and BS5839: Pt1: 2002 this link must be left OPEN.**

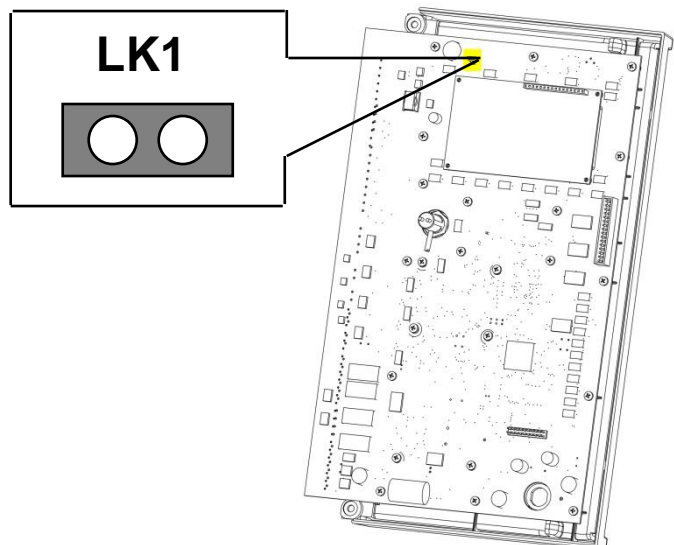

8 Zone Expansion Card

The 8 zone panel contains an 8 zone expansion PCB. This will already have been set up in the factory and programming options for the extra zones will be enabled. This card is not present in the 2-zone or 4-zone versions of the panel. The zone expansion PCB is not compatible with the 2-zone panel.

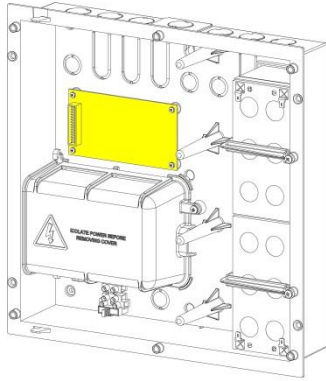

There is a connection using a ribbon cable from the connector labelled 'Ribbon Cable to CIE' on the expansion card to the connector labelled "Expansion Connector" on the rear of the CIE PCB.

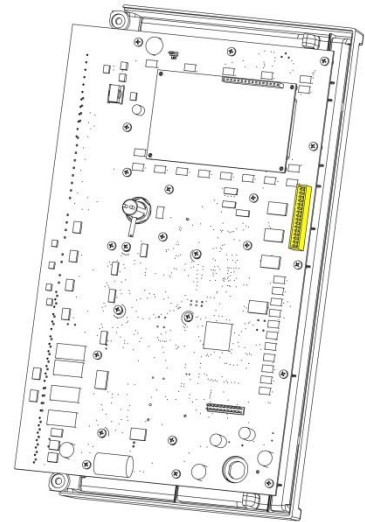

General Operation of Control Panel

Control Panel Front

Note : 4 Zone / 8 Zone Panel version shown

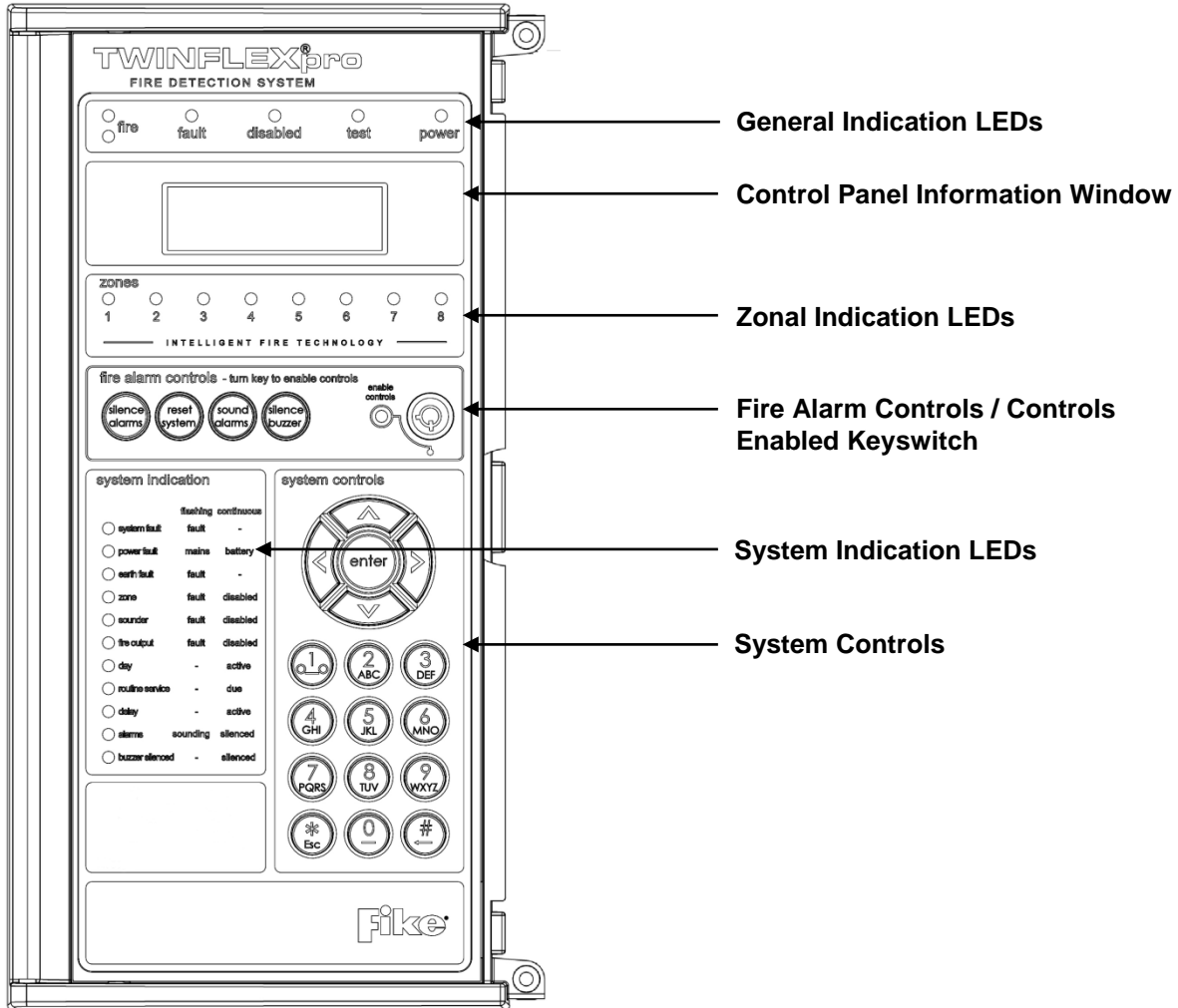

LED Indication

Note : 4 Zone / 8 Zone Panel version shown

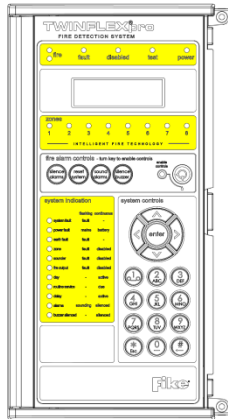

The operation of the LED indication on the front of the control panel is described below. The LED indication on the panel can also be confirmed by checking the message displayed in the panel information screen or by accessing the relevant event log from the panel menu.

Description	Colour	State	Reason
FIRE	Red	Continuous	The control panel is in the fire state. Other indicators will show the origin.
FAULT	Yellow	Continuous	The control panel is in the fault state. Other indicators will show the origin.
DISABLED	Yellow	Continuous	This indicates that a disablement action is in place. Enable all devices / actions to clear.
TEST	Yellow	Continuous	This indicates that a test routine is in place. End all tests to clear.
POWER	Green	Continuous	This indicates that power is being supplied to the control panel from either the 230V AC mains supply, or the standby batteries.
'ZONE 1-8'	Red	Flashing	A Manual Call Point in the zone indicated is in the alarm state and sending an alarm signal to the panel.
		Continuous	A Detector in the zone indicated is in the alarm state and sending an alarm signal to the panel.
SYSTEM FAULT	Yellow	Continuous	The system Fault LED indicates the presence of a processor or a checksum error. Power the system down to clear, reprogram all settings and test the system.
		Flashing	This LED will also be illuminated if the 'write protect / write enable' switch is left on whilst the system is not in the engineer menu.
POWER FAULT	Yellow	Flashing	A mains supply fault has been detected (check for a 230V AC supply on the incoming AC terminals).
		Continuous	A battery fault has been detected (check batteries and inline battery fuse).
EARTH FAULT	Yellow	Flashing	An earth fault has been detected where a path exists from the circuit wiring to earth. Remove circuits one at a time to discover which one, and then rectify.
ZONE	Yellow	Flashing	A fault condition is present on one of the zones or on a device connected to that zone.
		Continuous	A device or an action associated with a zone has been disabled.

SOUNDER	Yellow	Flashing Continuous	A fault condition is present on a monitored sounder circuit. A device or an action associated with the monitored sounder circuits has been disabled.
FIRE OUTPUT	Yellow	Flashing Continuous	A fault condition is present on a monitored Relay circuit. A device or an action associated with the monitored relay circuit has been disabled.
DAY	Yellow	Continuous	The system has gone into the less sensitive day mode as programmed.
ROUTINE SERVICE	Yellow	Continuous	The pre programmed service interval has expired and a weekly test or routine maintenance check is due.
DELAY	Yellow	Continuous	An action has been started which utilises a programmed delay.
ALARMS	Yellow	Flashing Continuous	The alarm sounders have been activated. The alarm sounders have been silenced whilst operating, and the system is awaiting a reset.
BUZZER SILENCED	Yellow	Continuous	The control panel buzzer has been silenced whilst operating and will stay silenced until another fault or relevant action occurs.

During a system fault, dependent upon what caused the fault, all relays will be off, all zones will be powered down, the zone, power fault and disabled LEDs will be on continuously. If any output is set to sounder then the Sounder LED will also be on continuously.

To recover from this, the panel should be powered down for approximately 2 minutes and then re-powered. This should be done by a competent person. If the panel appears to be operational, then a reset will clear the fault.

The only exception to this is the write enable switch. In access levels 1, 2A and 2B, if the switch is on, a system fault will be indicated on the LEDs and display. The fault relay will be off (to indicate a fault condition). It has no effect on the operation of the panel and serves as a reminder to the Engineer to switch off write enable before leaving the panel.

If the display is blank and no LEDs are showing, then either the unit is not powered, or the mains has failed and the batteries are lower than 21V. To recover from the low battery shut-off, power down completely and check that the batteries are no lower than 21V and then power up the system.

If the batteries are lower than 21V then they should be replaced or monitored during initial charging to ensure they recharge correctly. This could take several hours.

If the batteries are below 18V they should be replaced as they will have lost much of their capacity and are unlikely to recover. This could leave the system with no power under mains fail conditions.

Fire Alarm Controls

Note : 4 Zone / 8 Zone Panel version shown

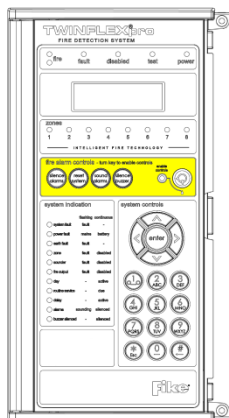

The main Fire Alarm Controls may be enabled by turning the key switch to the controls enabled position to go from access level 1 to AL2A, or by entering a valid access code to all modes above AL1. Access levels can only be entered from AL1, except from AL3A to AL3B where only the right hand side panel need be removed and the write enable switch turned on to enter AL3B from AL3A.

System Controls

Note : 4 Zone / 8 Zone Panel version shown

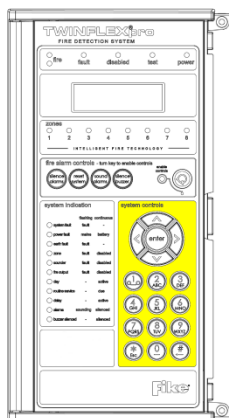

A context-driven, cursor highlighted-selection menu system is used to navigate around the menu system, automatically prompting you with the relevant options for your Access Level and system status.

The menus may be navigated in one of two ways as required:

1. Use the **UP / DOWN** keys to move the highlighted selection and press **ENTER** to select the chosen one.
2. Enter the desired option number and press **ENTER** to select it.

Press the **ESC** key to exit to the previous menu.

Access Levels and Codes

The menu system is divided into four access levels in order to restrict access to those who require it. For simple indication, the status of the **Controls Enabled** light will show the level selected as follows;

Access Level	Description	Controls Enabled LED	Key Operation
1 – NORM	Normal	OFF	N/A
2A – USER	User	ON	YES
2B – SUPR	Supervisor	SLOW FLASH	NO
3A – ENGR	Engineer	FAST FLASH	NO
3B – ENGR	Engineer	FAST FLASH	NO

Access to the menu system requires either the operation of the **enable controls** key for access to Access Level 2A (User), or the correct entry of the relevant code for access to all other levels, in order to protect against unauthorised access to the system. The codes may be changed using the relevant panel menu or via the TWINFLEX[®] pro OSP software. TWINFLEX[®] pro OSP software is only operational in Engineer Access Level 3B.

To enter Engineer Access Level 3B, remove the right hand cover and move the write enable switch to the ON position. Remember to put the switch back to the OFF position before leaving Engineer Level.

Access Level 1 (Normal): *Controls Enabled LED off*

At Access Level 1 (Normal), the main **Fire Alarm Controls** are disabled and the following **System Controls** will only be accessible if a fire, fault or disablement is active on the panel:

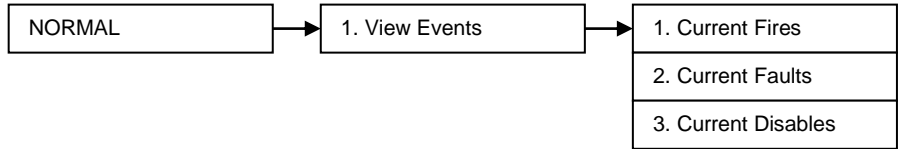

These are described below. Note that actual display indications may differ from those shown in the grey boxes below, depending on actual set up.

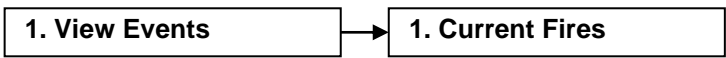

FIRE 001 OF 001
Z01: ZONE 01
Press <> OR Esc Key

The Active Log will display any current fires. These are displayed in text format and may be scrolled through by pressing the **UP** and **DOWN** keys. Press the **ESC** key to exit the menu.

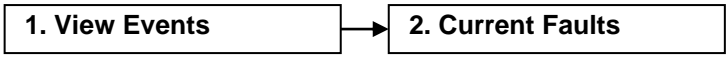

FAULT 001 OF 001
Z00: NA
Batt – Low Vtg
Press <> OR Esc Key

The Active Log will display any current faults. These are displayed in text format and may be scrolled through by pressing the **UP** and **DOWN** keys. Press the **ESC** key to exit the menu.

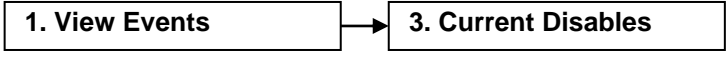

01/09/09 22:26 NORM
01.REMOTE FIRE
Press <> OR Esc Key

The Active Log will display any current disables. These are displayed in text format and may be scrolled through by pressing the **UP** and **DOWN** keys. Press the **ESC** key to exit the menu.

Note: When in the normal mode, the quiescent screen will automatically change to display any fires or faults on the system.

Access Level 2A (User): Enable Controls LED on

At Access Level 2A (User), the main **Fire Alarm Controls** are enabled and the following **System Controls** are accessible:

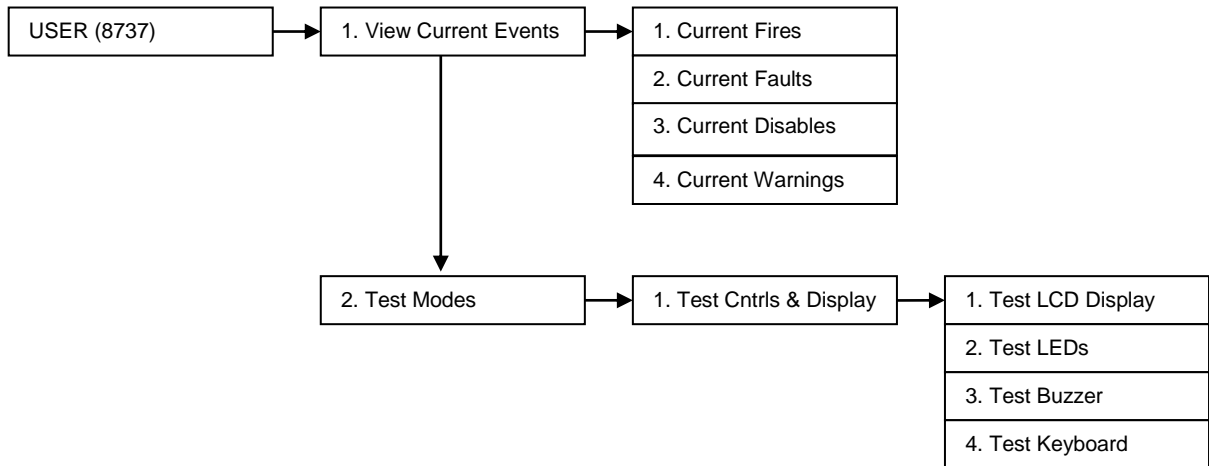

These are described below. Note that actual display indications may differ from those shown in the grey boxes below, depending on actual set up.

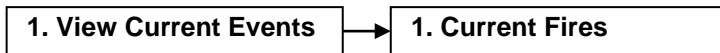

FIRE 001 OF 001
Z01: ZONE 01
 Press <> OR Esc Key

The Active Log will display any current fires. These are displayed in text format and may be scrolled through by pressing the **UP** and **DOWN** keys. Press the **ESC** key to exit the menu.

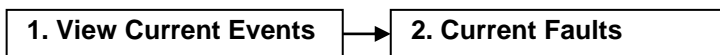

FAULT 001 OF 001
Z00: NA
Batt – Low Vtg
 Press <> OR Esc Key

The Active Log will display any current faults. These are displayed in text format and may be scrolled through by pressing the **UP** and **DOWN** keys. Press the **ESC** key to exit the menu.

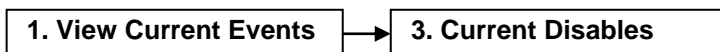

01/09/09 22:26 USER
01.REMOTE FIRE
 Press <> OR Esc Key

The Active Log will display any current disables. These are displayed in text format and may be scrolled through by pressing the **UP** and **DOWN** keys. Press the **ESC** key to exit the menu.

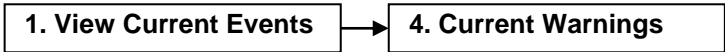

01/09/09 22:26 USER
 Press <> OR Esc Key

The Active Log will display any current warnings. These are displayed in text format and may be scrolled through by pressing the **UP** and **DOWN** keys. Press the **ESC** key to exit the menu.



[Empty box representing LCD display]

The Test Display function causes the LCD screen to blacken and the test LED to illuminate.



01/09/09 22:26 USER
 LEDs TESTING..
 LEDs ON
 Press Enter Key

The Test LEDs function causes the panel LEDs to toggle on/off and will illuminate to ensure correct operation. When this option is active, the test light will be illuminated.

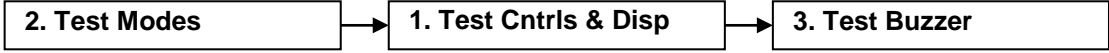

01/09/09 22:26 USER
 BUZZER TESTING..
 BUZZER ON
 Press Enter Key

The Test Buzzer function toggles on and off to ensure correct buzzer operation unless the buzzer has been disabled by fitting a jumper link to LK1 on the PCB. The test light will illuminate while this action is taken.



01/09/09 22:26 USER
 KEYBOARD TESTING..
 ENTER key PRESSED.
 Press Enter Key

The Test Keyboard function enables the user to select each button to ensure the correct function is shown on the screen. Press the **ESC** key **TWICE** to exit the menu.

Access Level 2B (Supervisor): Enable Controls LED flashing slowly

At Access Level 2B (Supervisor), the main **Fire Alarm Controls** are enabled and the following **System Controls** are accessible

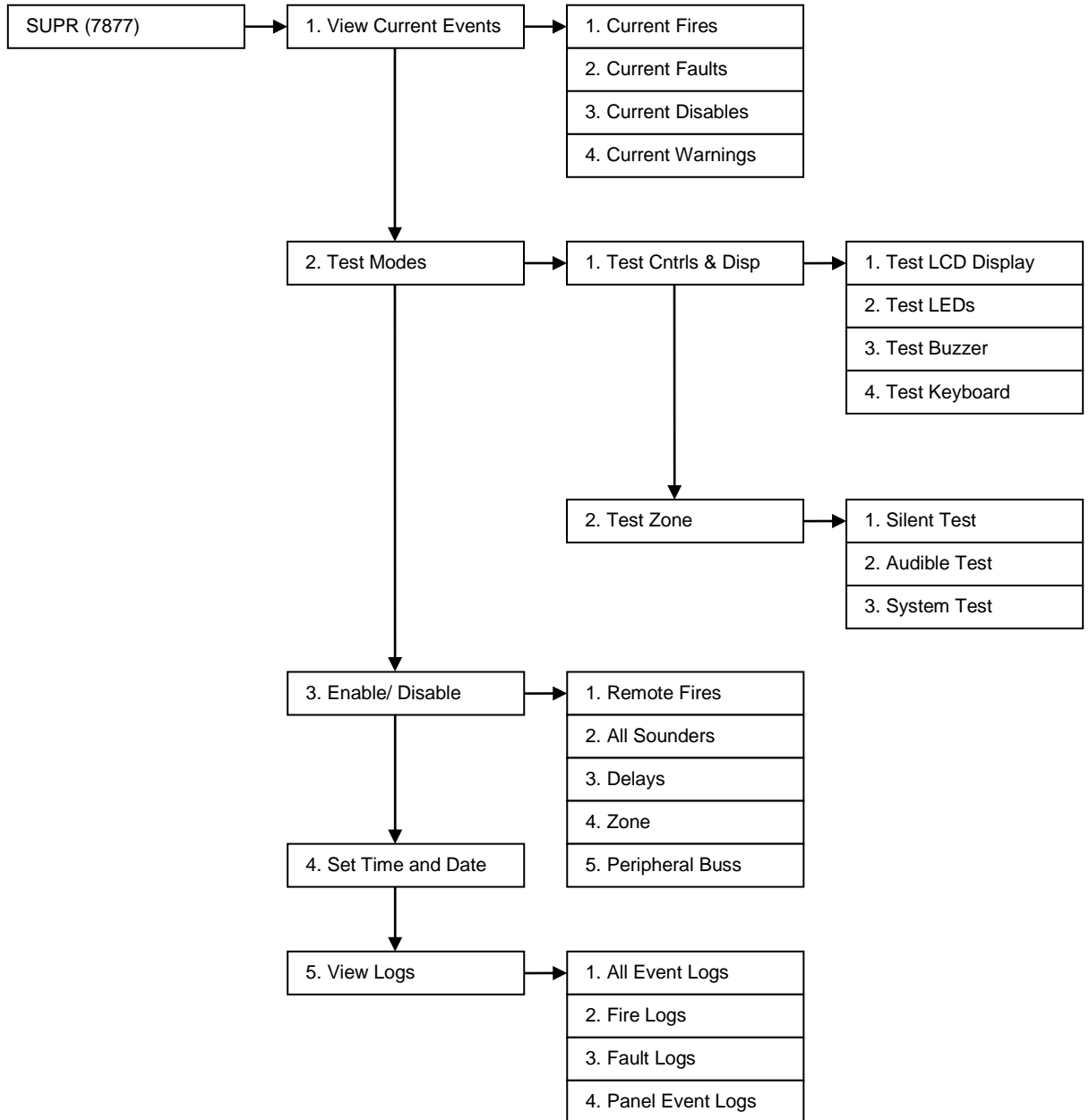

These are described below. Note that actual display indications may differ from those shown in the grey boxes below, depending on actual set up.

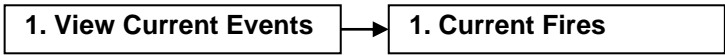

FIRE 001 OF 001
Z01: ZONE 01
Press <> OR Esc Key

The Active Log will display any current fires. These are displayed in text format and may be scrolled through by pressing the **UP** and **DOWN** keys. Press the **ESC** key to exit the menu.

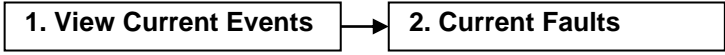

FAULT 001 OF 001
Z00: NA
Batt – Low Vtg
Press <> OR Esc Key

The Active Log will display any current faults. These are displayed in text format and may be scrolled through by pressing the **UP** and **DOWN** keys. Press the **ESC** key to exit the menu.

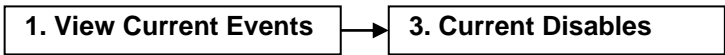

01/09/09 22:26 SUPR
01.REMOTE FIRE
Press <> OR Esc Key

The Active Log will display any current disables. These are displayed in text format and may be scrolled through by pressing the **UP** and **DOWN** keys. Press the **ESC** key to exit the menu.

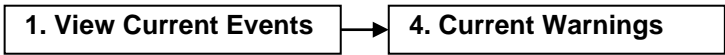

01/09/09 22:26 SUPR
Press <> OR Esc Key

The Active Log will display any current warnings. These are displayed in text format and may be scrolled through by pressing the **UP** and **DOWN** keys. Press the **ESC** key to exit the menu.

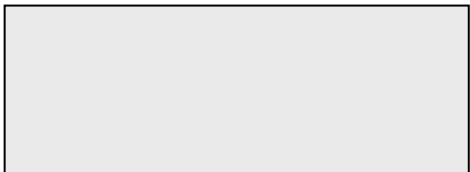

The Test Display function causes the LCD screen to blacken and the test LED to illuminate.



01/09/09 22:26 SUPR
LEDs TESTING..
LEDs ON
Press Enter Key

The Test LEDs function causes the panel LEDs to toggle on/off to test for correct operation. When this option is active, the test light will be illuminated.



01/09/09 22:26 SUPR
BUZZER TESTING..
BUZZER ON
Press Enter Key

The Test Buzzer function toggles on and off to ensure correct buzzer operation unless the buzzer has been disabled by fitting a jumper link to LK1 on the PCB. The test light will illuminate while this action is taken.



01/09/09 22:26 SUPR
KEYBOARD TESTING..
ENTER key PRESSED.
Press Enter Key

The Test Keyboard function enables the user to select each button to ensure the correct function is shown on the screen. Press the **ESC** key **TWICE** to exit the menu.

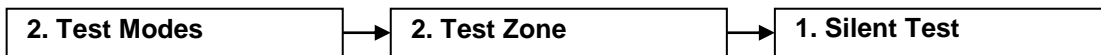

01/09/09 22:26 SUPR
SILENT TEST (ZONES).
ENTER ZONE:00
Press Enter Key

The Silent Test function allows the selection of one or more detection-zones to operate in a 'silent one-man walk test mode'. On triggering a device, the device LED operates and the event is recorded into the event log as a test activation, but the sounder does not sound and the control panel does not show an alarm. After approximately 5 seconds the system will reset the device and another may be tested. The control panel event log will indicate that a test mode has been selected. This operation will also enable the test LED.

01/09/09 22:26 SUPR
TEST ZONE 01
1.START 2.END
Press <> OR Esc Key

N.B. To put ALL zones into test, enter 00 for the zone number.

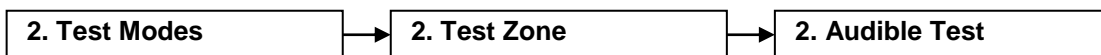

01/09/09 22:26 SUPR
AUDIBLE TEST (ZONES)
ENTER ZONE:00
Press Enter Key

The Local Audible Test function allows the selection of one or more detection-zones to operate in a 'one-man walk test mode with local sound'. On triggering a device, the device LED operates, the sounder within that device operates and the event is recorded into the event log as a test activation, but the control panel does not show an alarm. After approximately 5 seconds, the system will reset the device and another may be tested. The control panel event log will indicate that a test mode has been selected.

01/09/09 22:26 SUPR
TEST ALL ZONES
1.START 2.END
Press <> OR Esc Key

N.B. To put ALL zones into test enter 00 for the zone number.

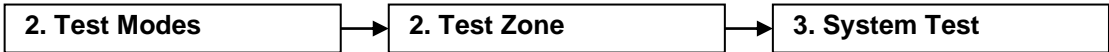

01/09/09 22:26 SUPR
SYSTEM TEST (ZONES)
ENTER ZONE:00
Press Enter Key

The System Test function allows the entire system to operate in a simple one-man walk test mode. On triggering a device the device LED operates and the event is recorded into the event log, all the assigned sounders operate for 10 seconds and the control panel indicates an alarm. After approximately 10 seconds, the system will reset the device and another may be tested. The control panel event log will indicate that a test mode has been selected. Please note that with the system test mode, only the sounders assigned to operate from that device will sound and any delays will still be present e.g. if a delay of 2 minutes is present, the system will have been reset before the sounders activate.

01/09/09 22:26 SUPR
TEST ALL ZONES
1.START 2.END
Press <> OR Esc Key

N.B. To put ALL zones into test enter 00 for the zone number.

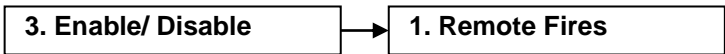

01/09/09 22:26 SUPR
REMOTE FIRE:DISABLED
1.DISABLE 2.ENABLE
Press <> OR Esc Key

This function allows the global disablement or enablement of all fire outputs on the panel. The control panel will indicate that disablements are present and a disablement event will be recorded to log.

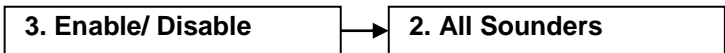

01/09/09 22:26 SUPR
SOUNDERS:DISABLED
1.DISABLE 2.ENABLE
Press <> OR Esc Key

This function allows the global disablement or enablement of all the sounders on the system. The control panel will indicate that disablements are present and a disablement event will be recorded to log.

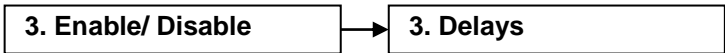

01/09/09 22:26 SUPR
DELAYS: ENABLED
1.DISABLE 2.ENABLE
Press <> OR Esc Key

This function allows output delays to be temporarily turned off.

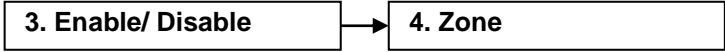

01/09/09 22:26 SUPR
ZONE(ENABLE/DISABLE)
ENTER ZONE:00
Press Enter Key

01/09/09 22:26 SUPR
ZONE: ENABLED
1.DISABLE 2.ENABLE
Press <> OR Esc Key

This function allows the disablement or enablement of a detection zone. Thus, all the input devices (Manual Call Points, detectors and inputs) within that detection-zone will be disabled. The control panel will indicate that disablements are present and a disablement event will be recorded to log. The device LED will still operate when the device is activated and an event will be recorded to log, but no programmed actions will occur. The sounder within the device will still operate if triggered from elsewhere on the system.

3. Enable/ Disable

5. Peripheral Buss

01/09/09 22:26 SUPR
 PERIPH BUSS: OFF
 1. OFF 2. ON
 Press <> OR Esc Key

This allows the Peripheral Buss to be switched on or off. This must be switched on when repeaters are used.

4. Set Time and Date

01/09/09 22:26 SUPR
 DATE: 01/09/09
 TIME: 22:36:00
 Press Enter Key

This allows the time and date to be adjusted. Use the **UP** and **DOWN** keys to move the cursor between options and the alphanumeric keypad to enter the code. Press the **ENTER** key to confirm the change. Note that this system will not keep time with BST/Daylight saving but will change date with leap years.

5. View Logs

1. All Event Logs

EVT 069 OF 069
 Z00: NA
 Engineer Mode
 01/09/09 22:26:01

The Event Log stores 500 fire, fault and system events which may be displayed in entirety, or displayed by category. These are displayed in text format and may be scrolled through by pressing the **UP** and **DOWN** keys. Press the **ESC** key to exit the menu.

5. View Logs

2. Fire Logs

EVT 014 OF 014
 Z01:
 Heat/Smoke
 01/09/09 22:28:01

The Fire Log will display a log of any fire conditions received by the panel. These are displayed in text format and may be scrolled through by pressing the **UP** and **DOWN** keys. Press the **ESC** key to exit the menu.

5. View Logs

3. Fault Logs

EVT 012 OF 012
 Z01:
 EOL Missing
 01/09/09 22:26:01

The Fault Log will display a log of any fault conditions received by the panel. These are displayed in text format and may be scrolled through by pressing the **UP** and **DOWN** keys. Press the **ESC** key to exit the menu.

5. View Logs

4. Panel Event Logs

EVT 069 OF 069
 Z00: NA
 Engineer Mode
 01/09/09 22:26:01

The Panel Event Log will display a log of events generated from the panel. These are displayed in text format and may be scrolled through by pressing the **UP** and **DOWN** keys. Press the **ESC** key to exit the menu.

Access Level 3 (Engineer): Controls Enabled LED flashing quickly

At Access Level 3A (Engineer), the main **Fire Alarm Controls** are enabled, and the following **System Controls** are accessible. To change options contained within the engineer menu, enter Access Level 3B. This is done by removing the right hand cover and moving the write enable switch to the ON position.

Note: A system reset must be done after any changes are made in order for them to take effect.

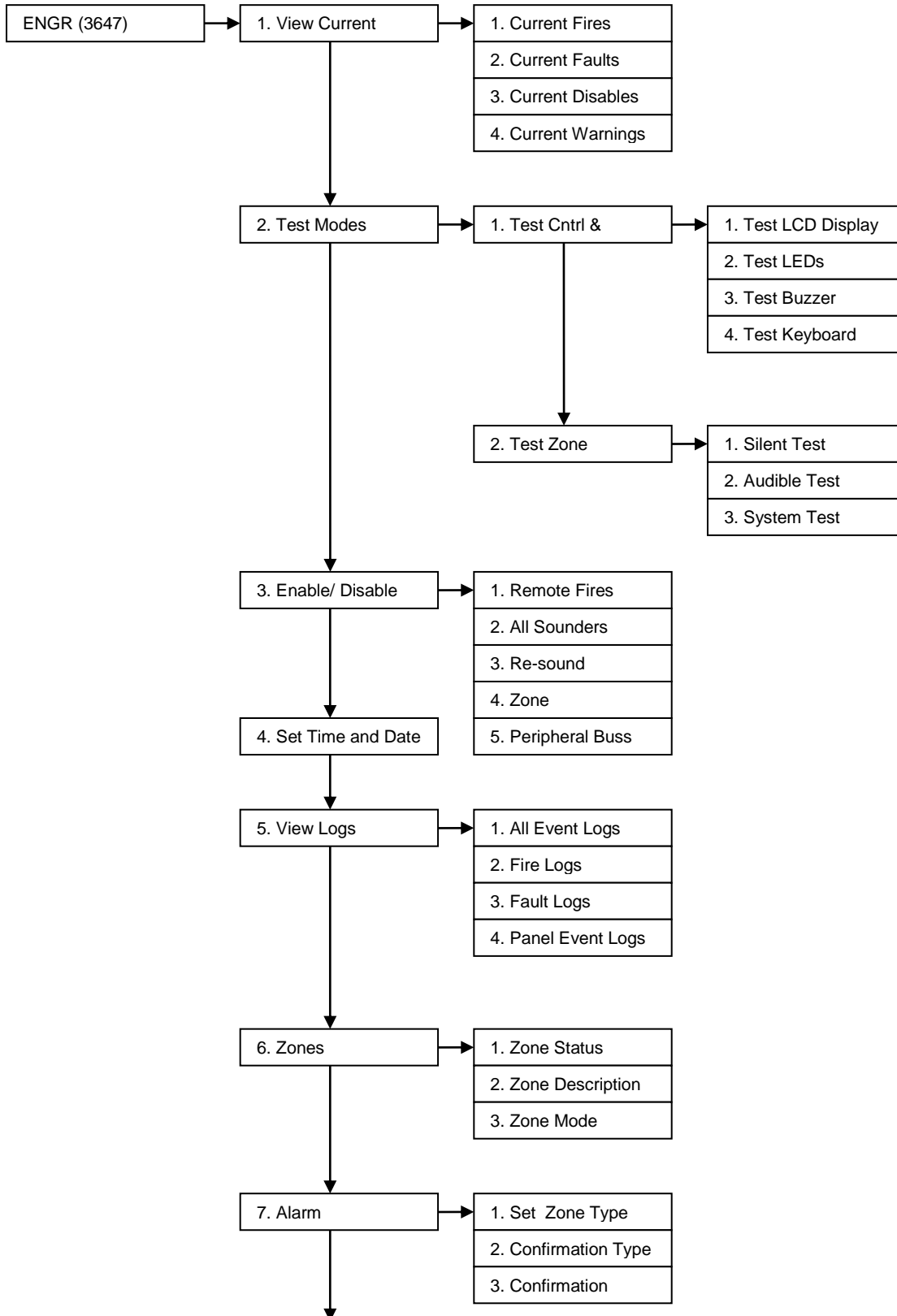

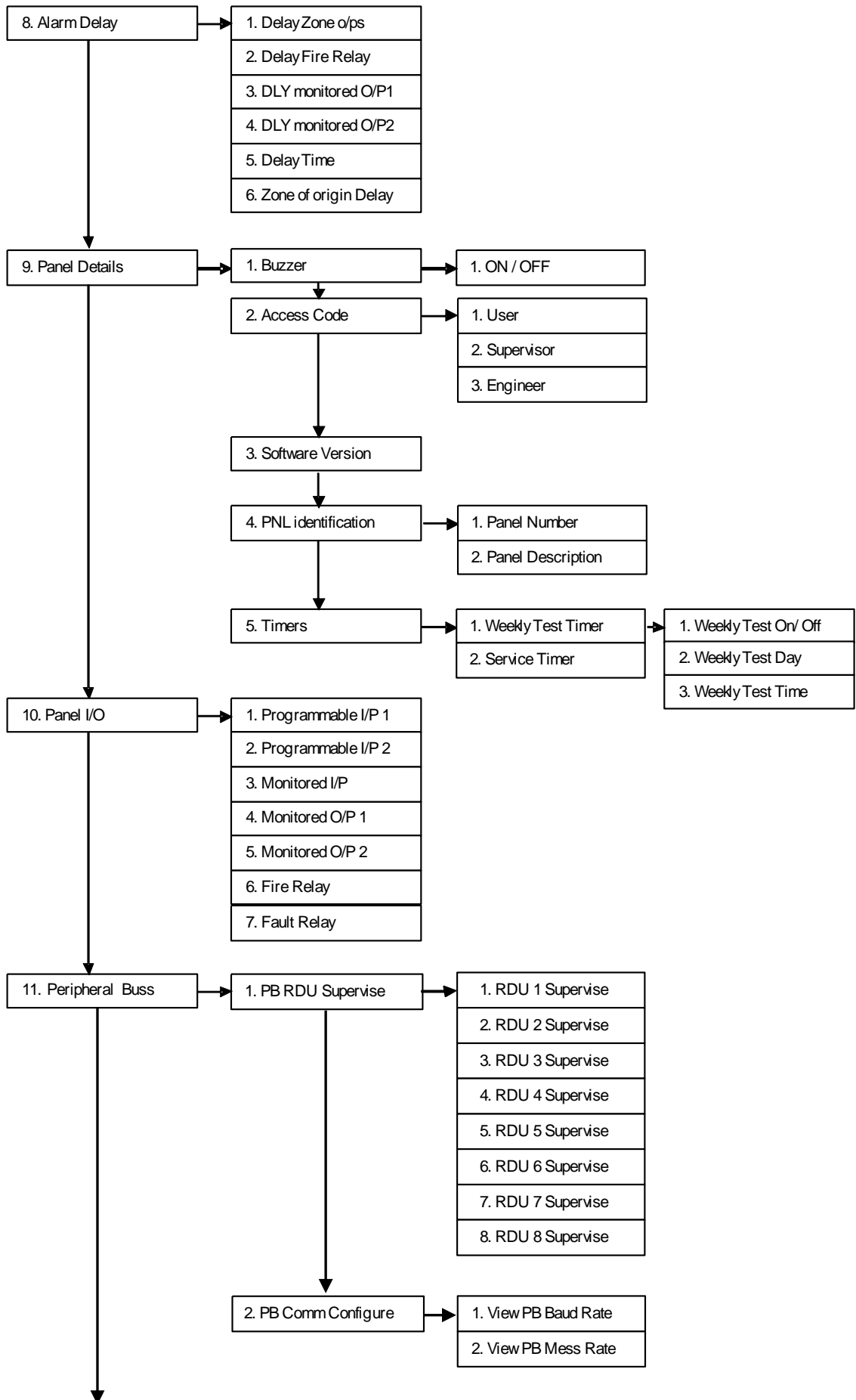

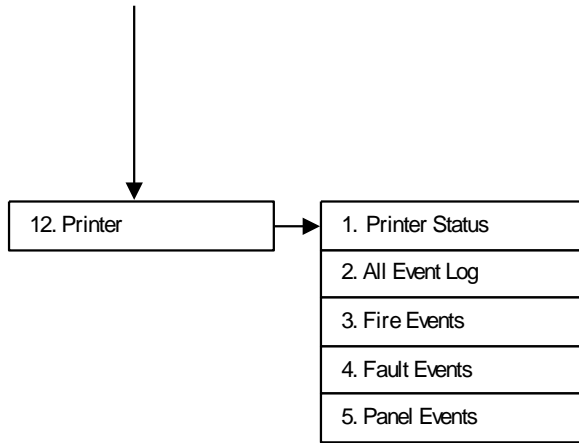

These are described below. Note that actual display indications may differ from those shown in the grey boxes below, depending on actual set up.

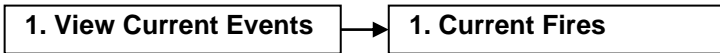

FIRE 001 OF 001
Z01: ZONE 01
Press <> OR Esc Key

The Active Log will display any current fires. These are displayed in text format and may be scrolled through by pressing the **UP** and **DOWN** keys. Press the **ESC** key to exit the menu.

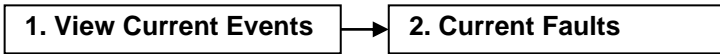

FAULT 001 OF 001
Z00: NA
Batt – Low Vtg
Press <> OR Esc Key

The Active Log will display any current faults. These are displayed in text format and may be scrolled through by pressing the **UP** and **DOWN** keys. Press the **ESC** key to exit the menu.

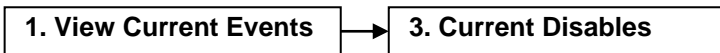

01/09/09 22:26 ENGR
01.REMOTE FIRE
Press <> OR Esc Key

The Active Log will display any current disables. These are displayed in text format and may be scrolled through by pressing the **UP** and **DOWN** keys. Press the **ESC** key to exit the menu.

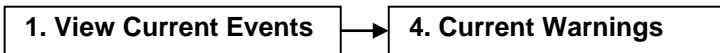

01/09/09 22:26 ENGR
Press <> OR Esc Key

The Active Log will display any current warnings. These are displayed in text format and may be scrolled through by pressing the **UP** and **DOWN** keys. Press the **ESC** key to exit the menu.

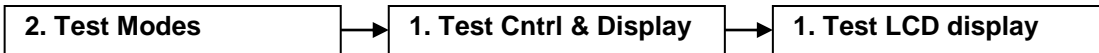

The Test Display function causes LCD screen to blacken and the test LED to illuminate.

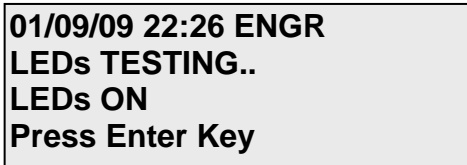
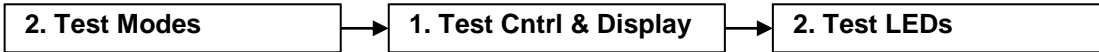

The Test LEDs function causes the panel LEDs to toggle on/off to ensure correct operation. When this option is active, the test light will be illuminated.

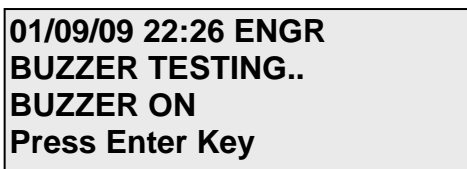
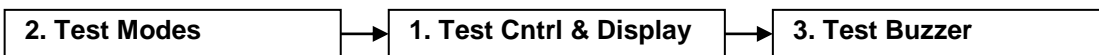

The Test Buzzer function toggles on and off to ensure correct buzzer operation unless the buzzer has been disabled by fitting a jumper link to LK1 on the PCB. The test light will illuminate while this action is taken.

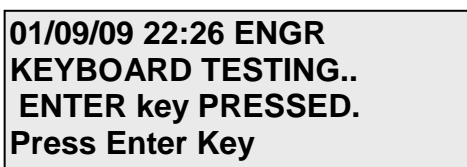
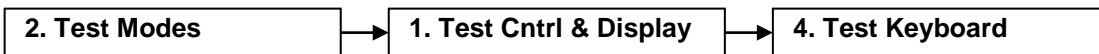

The Test Keyboard function enables the user to select each button to ensure the correct function on the screen. Press the **ESC** key **TWICE** to exit the menu.

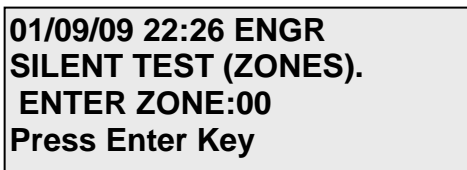
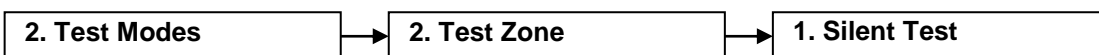

The Silent Test function allows the selection of one or more detection-zones to operate in a 'silent one-man walk test mode'. On triggering a device, the device LED operates and the event is recorded into the event log as a test activation, but the sounder does not sound and the control panel does not show an alarm. After approximately 5 seconds the system will reset the device and another may be tested. The control panel event log will indicate that a test mode has been selected. This operation will also enable the test LED.

N.B. To put ALL zones into test enter 00 for the zone number.

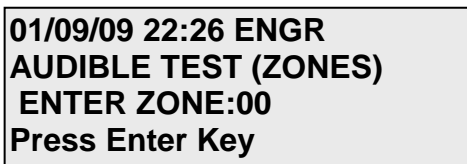
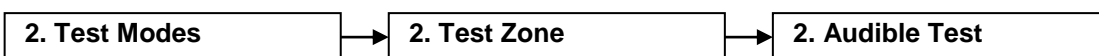
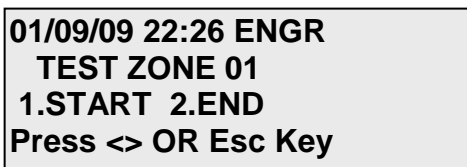

The Local Audible Test function allows the selection of one or more detection-zones to operate in a 'one-man walk test mode with local sound'. On triggering a device, the device LED operates, the sounder within that device operates and the event is recorded into the event log as a test activation, but the control panel does not show an alarm. After

01/09/09 22:26 ENGR
TEST ALL ZONES
 1.START 2.END
 Press <> OR Esc Key

approximately 5 seconds, the system will reset the device and another may be tested. The control panel event log will indicate that a test mode has been selected.

N.B. To put ALL zones into test enter 00 for the zone number.

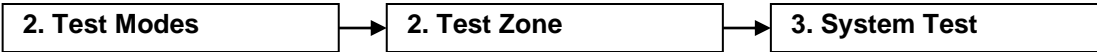

01/09/09 22:26 ENGR
SYSTEM TEST (ZONES)
 ENTER ZONE:00
 Press Enter Key

The System Test function allows the entire system to operate in a simple one-man walk test mode. On triggering a device, the device LED operates and the event is recorded into the event log, all the assigned sounders operate for 10 seconds and the control panel indicates an alarm. After approximately 10 seconds, the system will reset the device, and another may be tested. The control panel event log will indicate that a test mode has been selected. Please note that with the system test mode, only the sounders assigned to operate from that device will sound, and any delays will still be present. e.g. if a delay of 2 minutes is present, the system will have been reset before the sounders activate.

N.B. To put ALL zones into test enter 00 for the zone number.

01/09/09 22:26 ENGR
TEST ALL ZONES
 1.START 2.END
 Press <> OR Esc Key

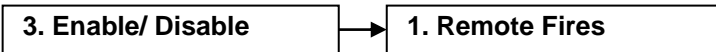

01/09/09 22:26 ENGR
REMOTE FIRE:DISABLED
 1.DISABLE 2.ENABLE
 Press <> OR Esc Key

This function allows the global disablement or enablement of all fire outputs on the panel. The control panel will indicate that disablements are present and a disablement event will be recorded to log.

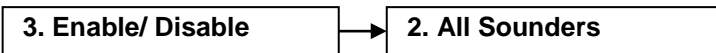

01/09/09 22:26 ENGR
SOUNDERS:DISABLED
 1.DISABLE 2.ENABLE
 Press <> OR Esc Key

This function allows the global disablement or enablement of all the sounders on the system. The control panel will indicate that disablements are present and a disablement event will be recorded to log.

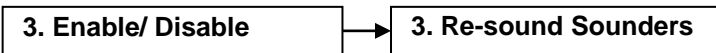

01/09/09 22:26 ENGR
OPTION : AUTOMATIC
 1.MANUAL 2.AUTO
 Press <> OR Esc Key

This function allows the sounders to either re-sound on another alarm or to remain in the silenced mode.

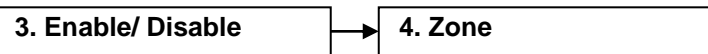

01/09/09 22:26 ENGR
ZONE(ENABLE/DISABLE)
 ENTER ZONE:00
 Press Enter Key

This function allows the disablement or enablement of a detection-zone. Thus, all the input devices (Manual Call Points, detectors and inputs) within that detection-zone will be disabled. The control panel will indicate that disablements are present and a disablement event will be recorded to log. The device LED will still operate when the device is activated and an event will be recorded to log, but no programmed

01/09/09 22:26 ENGR
 ZONE: ENABLED
 1.DISABLE 2.ENABLE
 Press <> OR Esc Key

actions will occur. The sounder within the device will still operate if triggered from elsewhere on the system.

3. Enable/ Disable → 5. Peripheral Buss

01/09/09 22:26 SUPR
 PERIPH BUSS: OFF
 2. OFF 2. ON
 Press <> OR Esc Key

This allows the Peripheral Buss to be switched on or off. This must be switched on when repeaters are used.

4. Set Time and Date

01/09/09 22:26 ENGR
 DATE: 01/09/09
 TIME: 22:36:00
 Press Enter Key

This allows the time and date to be adjusted. Use the **UP** and **DOWN** keys to move the cursor between options and the alphanumeric keypad to enter the code. Press the **ENTER** key to confirm the change. Note that this system will not keep time with BST/Daylight saving but will change date with leap years.

5. View Logs → 1. All Event Logs

EVT 069 OF 069
 Z00: NA
 Engineer Mode 01/09/09
 22:26:01

The Event Log stores 500 fire, fault and system events which may be displayed in entirety, or displayed by category. These are displayed in text format and may be scrolled through by pressing the **UP** and **DOWN** keys. Press the **ESC** key to exit the menu.

5. View Logs → 2. Fire Logs

EVT 014 OF 014
 Z01:
 Heat/Smoke
 01/09/09 22:28:01

The Fire Log will display a log of any fire conditions received by the panel. These are displayed in text format and may be scrolled through by pressing the **UP** and **DOWN** keys. Press the **ESC** key to exit the menu.

5. View Logs → 3. Fault Logs

EVT 012 OF 012
 Z01:
 EOL Missing 01/09/09
 22:26:01

The Fault Log will display a log of any fault conditions received by the panel. These are displayed in text format and may be scrolled through by pressing the **UP** and **DOWN** keys. Press the **ESC** key to exit the menu.

5. View Logs

4. Panel Event Logs

```
EVT 069 OF 069
Z00: NA
Engineer Mode    01/09/09
22:26:01
```

The Panel Event Log will display a log of events generated from the panel. These are displayed in text format and may be scrolled through by pressing the **UP** and **DOWN** keys. Press the **ESC** key to exit the menu.

6. Zones

1. Zone Status

```
01/09/09 22:26 ENGR
ZONE STATUS (ON/OFF)
ENTER ZONE:00
Press Enter Key
```

The Zone Status will display the current zone status of any zone selected. These are displayed in text format and may be altered by pressing the **LEFT** and **RIGHT** keys. Once the correct setting is chosen press the **ENTER** key.

- 1. ON – Zone is active.
 - 2. OFF – Zone is switched off.
- The supply voltage to the selected zone will also be switched off.**

```
01/09/09 22:26 ENGR
ZONE STATUS: OFF
1.ON 2.OFF
Press <> OR Esc Key
```

6. Zones

2. Zone Description

```
01/09/09 22:26 ENGR
ZONE NAMES
ENTER ZONE:00
Press Enter Key
```

The Zone description will display the zone description for the selected zone. These are displayed in text format and may be scrolled through by pressing the **LEFT** and **RIGHT** keys. To change the text, highlight the character to be changed and use the alphanumeric keypad to change that character. After changing a character, the cursor will automatically move to the next position. To confirm the changes press **ENTER**.

```
01/09/09 22:26 ENGR
EDIT ZONE 01
NAME: ZONE 01
Press Enter Key
```

6. Zones

3. Zone Mode

```
01/09/09 22:26 ENGR
ZN TYPE: CP/DET
1.CP/DET 2.CP/SM/HT
Press <> OR Esc Key
```

This active control will allow the engineer to choose the type of detectors that are to be used on the system. Use the **LEFT** and **RIGHT** keys to toggle through the following options. Once the correct option has been selected, press the **ENTER** key.

- 1. CP/DET – Original style TWINFLEX[®] Multipoint.
- 2. CP/SM/HT – New TWINFLEX[®] ASD Device

7. Alarm configuration

1. Set Zone Type

01/09/09 22:26 ENGR
SET ZONE TYPE
ENTER ZONE:00
Press Enter Key

This active control will allow the engineer to change the selected zone type for 'alarm confirmation'. Use the **LEFT** and **RIGHT** keys to toggle through the following options. Once the correct option has been selected, press the **ENTER** key.

01/09/09 22:26 ENGR
ZONE: COMMUNAL
1.COMM. 2.DWELL.
Press <> OR Esc Key

1. COMM. – Communal Zone – Smoke detectors on this zone will immediately activate all sounders and outputs (subject to any other delays programmed into the system).
2. DWELL – Dwelling Zone – Smoke detectors on this zone will be subject to the 'alarm confirmation delay' (for more information on this setting please refer to the 'alarm confirmation' section).

7. Alarm configuration

2. Confirmation Type

01/09/09 22:26 ENGR
OPTION : ZONAL
1.SYSTEM 2.ZONAL
Press <> OR Esc Key

This active control will allow the engineer to change the type of 'alarm confirmation' implemented. Use the **LEFT** and **RIGHT** keys to toggle through the following options. Once the correct option has been selected press the **ENTER** key.

1. SYSTEM – If any smoke detector on any zone enters an alarm condition whilst a detector is already in 'alarm confirmation', the panel will override the delay and trigger a full alarm.
2. ZONAL – If any smoke detector on the same zone as a detector already in 'alarm confirmation' activates, the panel will override the delay and trigger a full alarm. If the next detector that triggers is on a different zone, then operation will be as per the zone type for that zone. More than one confirmation can be running at a time in this mode

7. Alarm configuration

3. Confirmation Delay

01/09/09 22:26 ENGR
CONFIRMATION DELAY
DELAYS=1 (1-5 MIN)
Press Enter Key

This active control will allow the engineer to set the 'alarm confirmation' delay timer. Press 1 – 5 to set the timer from 1 Minute to 5 Minutes, then press **ENTER** to confirm the change.

8. Alarm Delay

1. Delay Zone O/Ps

```
01/09/09 22:26 ENGR
SET DELAY ZONE O/Ps
ENTER ZONE:00
Press Enter Key
```

This active control will allow the engineer to set an alarm delay for all sounders and outputs on the selected zone. Use the **LEFT** and **RIGHT** keys to toggle through the following options. Once the correct option has been selected, press the **ENTER** key.

1. INSTANT – When the panel receives a fire input, all sounders and outputs on the zone will immediately activate.
2. DELAYED – When the panel receives a fire input, all sounders and outputs on the selected zone will be delayed for the time period set in the ‘Delay Timer’ menu.

```
01/09/09 22:26 ENGR
ZONE: INSTANT
1.INSTANT 2.DELAYED
Press <> OR Esc Key
```

8. Alarm Delay

2. Delay Fire Relay

```
01/09/09 22:26 ENGR
FIRE RELAY: INSTANT
1.INSTANT 2.DELAYED
Press <> OR Esc Key
```

This active control will allow the engineer to set an alarm delay for the panel fire relay. Use the **LEFT** and **RIGHT** keys to toggle through the following options. Once the correct option has been selected, press the **ENTER** key.

1. INSTANT – When the panel receives a fire input the fire relay will immediately activate.
2. DELAYED – When the panel receives a fire input the fire relay will be delayed for the time period set in the ‘Delay Timer’ menu.

8. Alarm Delay

3. DLY monitored O/P1

```
01/09/09 22:26 ENGR
MON O/P 1 : INSTANT
1.INSTANT 2.DELAYED
Press <> OR Esc Key
```

This active control will allow the engineer to set an alarm delay for Monitored Output 1. Use the **LEFT** and **RIGHT** keys to toggle through the following options. Once the correct option has been selected, press the **ENTER** key.

1. INSTANT – When the panel receives a fire input Monitored Output 1 will immediately activate.
2. DELAYED – When the panel receives a fire input Monitored Output 1 will be delayed for the time period set in the ‘Delay Timer’ menu.

8. Alarm Delay

4. DLY monitored O/P 2

01/09/09 22:26 ENGR
MON O/P 2 : DELAYED
1.INSTANT 2.DELAYED
Press <> OR Esc Key

This active control will allow the engineer to set an alarm delay for Monitored Output 2. Use the **LEFT** and **RIGHT** keys to toggle through the following options. Once the correct option has been selected, press the **ENTER** key.

1. INSTANT – When the panel receives a fire input Monitored Output 2 will immediately activate.
2. DELAYED – When the panel receives a fire input Monitored Output 2 will be delayed for the time period set in the 'Delay Timer' menu.

8. Alarm Delay

5. Delay Timer

01/09/09 22:26 ENGR
ALARM DELAY
DELAYS=0 (0-5 MIN)
Press Enter Key

This active control will allow the engineer to set the alarm delay timer. Press 0 – 5 to set the timer from No Delay to 5 Minutes, then press **ENTER** to confirm the change. If a delay time is set, then the Delay LED will be lit. Delayed zones or outputs will not be delayed if a zero time is selected.

8. Alarm Delay

6. Zone of Origin Delay

01/09/09 22:26 ENGR
ORIGIN ZN : INSTANT
1.INSTANT 2.SETTING
Press <> OR Esc Key

This active control will allow the engineer to automatically override any delay in the zone of origin. Use the **LEFT** and **RIGHT** keys to toggle through the following options. Once the correct option has been selected press the **ENTER** key.

1. INSTANT – If any zone programmed with an output delay enters an alarm condition, the output delay on that initiating zone will be cancelled. All other zones will operate as per their output delay settings.
2. SETTING – All zones will operate as per their output delay settings.

9. Panel Details

1. Buzzer

1. ON / OFF

01/09/09 22:26 ENGR
BUZZER: OFF
1.ON 2.OFF
Press <> OR Esc Key

This active control will allow the engineer to temporarily switch off the panel buzzer whilst in engineer mode. When the user exits engineer mode, the buzzer will be re-enabled. Use the **LEFT** and **RIGHT** keys to toggle through the options, then press **ENTER** to confirm the change.



EXISTING CODE:8737
NEW CODE :
CONFIRM CODE :
Press <> OR Esc Key

This active control will allow the engineer to change the code for access to the user menus. Use the **UP** and **DOWN** keys to move the cursor between options and the alphanumeric keypad to enter the code. Press the **ENTER** key to confirm the change.



EXISTING CODE:7877
NEW CODE :
CONFIRM CODE :
Press <> OR Esc Key

This active control will allow the engineer to change the code for access to the supervisor menus. Use the **UP** and **DOWN** keys to move the cursor between options and the alphanumeric keypad to enter the code. Press the **ENTER** key to confirm the change.



EXISTING CODE:3647
NEW CODE :
CONFIRM CODE :
Press <> OR Esc Key

This active control will allow the engineer to change the code for access to the engineer menus. Use the **UP** and **DOWN** keys to move the cursor between options and the alphanumeric keypad to enter the code. Press the **ENTER** key to confirm the change.

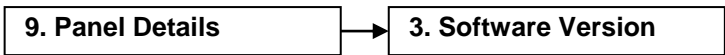

01/09/09 20:13 ENGR
SOFTWARE VERSION
V1.04
Press Enter Key

This active control will allow the engineer to view the version of panel operating software implemented.

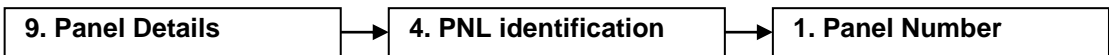

01/09/09 20:13 ENGR
OLD PANEL ID:01
NEW PANEL ID:00
Press <> OR Esc Key

This active control will allow the engineer to view or change the panel ID Number. This is the number that identifies the panel on the network. Use the **UP** and **DOWN** keys to move the cursor between options and the alphanumeric keypad to enter the new ID Number.
Please Note: Panel networking functions are not currently available.

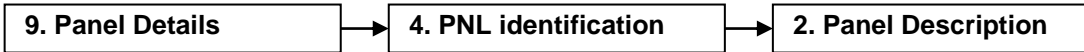

01/09/09 20:13 ENGR
 EDIT PANEL NAME
 NAME: TWINFLEX
 Press Enter Key

This active control will allow the engineer to view or change the panel description. This is the name that identifies the panel on the network. Use the **LEFT** and **RIGHT** keys to move the cursor. To change the text, highlight the character to be changed and use the alphanumeric keypad to change that character. After changing a character, the cursor will automatically move to the next position. To confirm the changes press **ENTER** to accept the new description.
Please Note: Panel networking functions are not currently available.



01/09/09 20:13 ENGR
 WEEKLY TEST: OFF
 1.ON 2.OFF
 Press <> OR Esc Key

This active control will allow the engineer to enable or disable the weekly test timer. Use the **LEFT AND RIGHT** keys to toggle between the following options. To confirm the changes press **ENTER**.

- 1. ON – Once a week at a determined day and time the routine service light will illuminate and the fault buzzer will sound to remind the user to perform their weekly test. The user will need to enter the **user code** or turn the key and reset the panel to clear.
- 2. OFF – Weekly test timer is switched off.

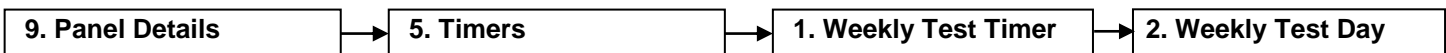

01/09/09 20:13 ENGR
 1.MONDAY
 2.TUESDAY
 Press Enter Key

This active control will allow the engineer to view or change the day of the week on which the weekly test will be indicated. Use the **UP** and **DOWN** keys to toggle between the days of the week. To confirm the changes press **ENTER**.

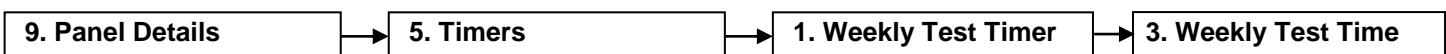

01/09/09 20:13 ENGR
 WEEKLY TEST TIMER
 TIME= 10:00 (HH:MM)
 Press Enter Key

This active control will allow the engineer to view or change the time of day at which the weekly test will be indicated. Use the alphanumeric keypad to enter a new time. To confirm the changes press **ENTER**.



**01/09/09 20:13 ENGR
SERVICE TIMER
TIME= 06(0-99) WEEKS
Press Enter Key**

This active control will allow the engineer to view or change the number of weeks between routine services. Use the alphanumeric keypad to enter a time interval up to 99 weeks. To confirm the changes press **ENTER**. When the routine service is indicated, the user must enter the **engineer code** and reset the panel to clear.

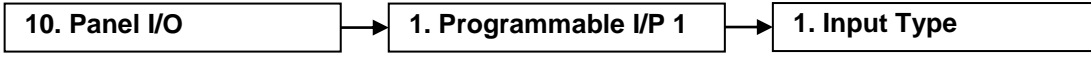

**01/09/09 20:13 ENGR
1.CONTROL EVENT
2.REMOTE FIRE EVENT
Press Enter Key**

This active control will allow the engineer to view or change the operation of programmable input 1. Use the UP and DOWN arrow keys to toggle through the following options. To confirm the changes press **ENTER**.

- | | |
|------------------------|--|
| 1. CONTROL EVENT – | Operation of I/P 1 will operate a control function on the panel. |
| 2. REMOTE FIRE EVENT– | Operation of I/P 1 will signal a remote fire input at the control panel. Panel outputs will be triggered and fire indication will be shown at the control panel. |
| 3. TECHNICAL EVENT – | Operation of I/P 1 will signal a technical event at the control panel. Panel outputs will be triggered but the control panel will read technical alarm and no fire indication will be given. |
| 4. DISABLEMENTS – | Operation of I/P 1 will activate a disablement on the control panel. |
| 5. DAY-NIGHT MODE – | Operation of I/P 1 will activate the day mode on the control panel
(TWINFLEX[®] Multipoint devices will be disabled; the future TWINFLEX[®] ASD devices will be disabled for smoke only but not for heat). |
| 6. PROGRAM I/P 1 OFF – | I/P 1 will not be active. |

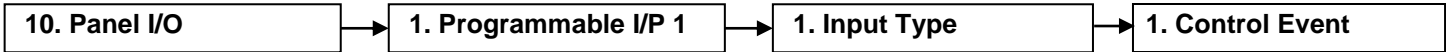

01/09/09 20:13 ENGR
1.SILENCE ALARMS
2.RESET SYSTEM
 Press Enter Key

This active control will allow the engineer to view or change the operation of the control event set for programmable input 1. Use the **UP** and **DOWN** arrow keys to toggle through the following options. To confirm the changes press **ENTER**.

- 1. SILENCE ALARMS – Operation of I/P 1 will silence the alarms.
- 2. RESET SYSTEM – Operation of I/P 1 will reset the panel.
- 3. SOUND ALARMS – Operation of I/P 1 will send the evacuate signal to the panel.
- 4. SILENCE BUZZER – Operation of I/P 1 will silence the control panel buzzer.



01/09/09 20:13 ENGR
1.REMOTE FIRE- FULL
2.REM FIRE,NO RELAYS
 Press Enter Key

This active control will allow the engineer to view or change the operation of the remote fire event set for programmable input 1. Use the **UP** and **DOWN** arrow keys to toggle through the following options. To confirm the changes press **ENTER**.

- 1. REMOTE FIRE FULL – Operation of I/P 1 will signal a remote fire at the control panel. All sounders and relays will operate.
- 2. REMOTE FIRE NO RELAYS – Operation of I/P 1 will signal a remote fire at the control panel and only the sounders will operate.

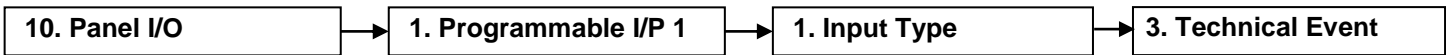

01/09/09 20:13 ENGR
TECHNICAL EVENT
1.LATCH 2.NON-LATCH
 Press Enter Key

This active control will allow the engineer to view or change the operation of the technical event set for programmable input 1. Use the **UP** and **DOWN** arrow keys to toggle through the following options. To confirm the changes press **ENTER**.

- 1. LATCH – Operation of I/P 1 will signal a technical event at the control panel. All outputs will trigger and the panel will latch into fire.
- 2. NON-LATCH – Operation of I/P 1 will signal a technical event at the control panel. All outputs will trigger for as long as the input is activated.

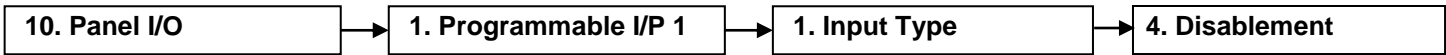

01/09/09 20:13 ENGR
1. DISABLE SOUNDERS
2. DISABLE REM.FIRE
 Press Enter Key

This active control will allow the engineer to view or change the operation of the disablement event set for programmable input 1. Use the **UP** and **DOWN** arrow keys to toggle through the following options. To confirm the changes press **ENTER**.

- | | |
|-------------------------|---|
| 1. DISABLE SOUNDERS – | Operation of I/P 1 will disable the sounders. |
| 2. DISABLE REM.FIRE – | Operation of I/P 1 will disable all remote fire signals. |
| 3. DIS SNDRS/REM FIRE – | Operation of I/P 1 will disable all sounders and remote fire signals. |
| 4. DISABLE BUZZER – | Operation of I/P 1 will disable all remote fire signals. |

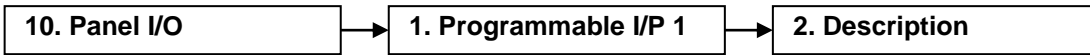

01/09/09 22:26 ENGR
EDIT PROGRAMABLE IP1
NAME: PROG I/P 1
 Press Enter Key

This option allows the engineer to change the text that will be displayed on the panel when Programmable I/P 1 is activated. This is displayed in text format and may be scrolled through by pressing the **LEFT** and **RIGHT** keys. To change the text, highlight the character to be changed and use the alphanumeric keypad to change that character. After changing a character, the cursor will automatically move to the next position. To confirm the changes press **ENTER**.

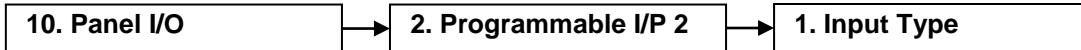

01/09/09 20:13 ENGR
1.CONTROL EVENT
2.REMOTE FIRE EVENT
 Press Enter Key

This active control will allow the engineer to view or change the operation of programmable input 2. Use the **UP** and **DOWN** arrow keys to toggle through the following options. To confirm the changes press **ENTER**.

- 1. CONTROL EVENT – Operation of I/P 2 will operate a control function on the panel.
- 2. REMOTE FIRE EVENT– Operation of I/P 2 will signal a remote fire input at the control panel. Panel outputs will be triggered and fire indication will be shown at the control panel.
- 3. TECHNICAL EVENT – Operation of I/P 2 will signal a technical event at the control panel. Panel outputs will be triggered but the control panel will read technical alarm and no fire indication will be given.
- 4. DISABLEMENTS – Operation of I/P 2 will activate a disablement on the control panel.
- 5. DAY-NIGHT MODE – Operation of I/P 2 will activate the day mode on the control panel
(TWINFLEX[®] Multipoint devices will be disabled; the future TWINFLEX[®] ASD devices will be disabled for smoke only but not for heat).
- 6. PROGRAM I/P 2 OFF – I/P 2 will not be active.

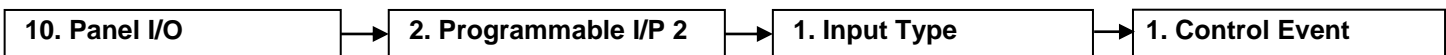

01/09/09 20:13 ENGR
1.SILENCE ALARMS
2.RESET SYSTEM
 Press Enter Key

This active control will allow the engineer to view or change the operation of the control event set for programmable input 2. Use the **UP** and **DOWN** arrow keys to toggle through the following options. To confirm the changes press **ENTER**.

- 1. SILENCE ALARMS – Operation of I/P 2 will silence the alarms.
- 2. RESET SYSTEM – Operation of I/P 2 will reset the panel.
- 3. SOUND ALARMS – Operation of I/P 2 will send the evacuate signal to the panel.
- 4. SILENCE BUZZER – Operation of I/P 2 will silence the control panel buzzer.

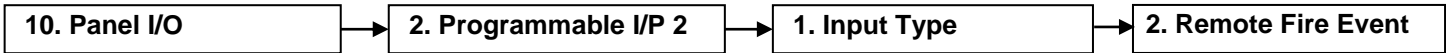

01/09/09 20:13 ENGR
1.REMOTE FIRE- FULL
2.REM FIRE,NO RELAYS
Press Enter Key

This active control will allow the engineer to view or change the operation of the remote fire event set for programmable input 2. Use the **UP** and **DOWN** arrow keys to toggle through the following options. To confirm the changes press **ENTER**.

- 1. REMOTE FIRE FULL – Operation of I/P 2 will signal a remote fire at the control panel. All sounders and relays will operate.
- 2. REMOTE FIRE NO RELAYS – Operation of I/P 2 will signal a remote fire at the control panel and only the sounders will operate.



01/09/09 20:13 ENGR
TECHNICAL EVENT
1.LATCH 2.NON-LATCH
Press Enter Key

This active control will allow the engineer to view or change the operation of the technical event set for programmable input 2. Use the **UP** and **DOWN** arrow keys to toggle through the following options. To confirm the changes press **ENTER**.

- 1. LATCH – Operation of I/P 2 will signal a technical event at the control panel. All outputs will trigger and the panel will latch into fire.
- 2. NON-LATCH – Operation of I/P 2 will signal a technical event at the control panel. All outputs will trigger for as long as the input is activated.

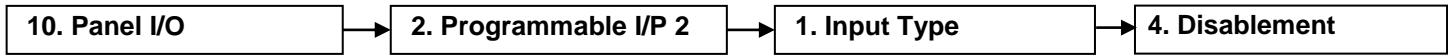

01/09/09 20:13 ENGR
1. DISABLE SOUNDERS
2. DISABLE REM.FIRE
 Press Enter Key

This active control will allow the engineer to view or change the operation of the disablement event set for programmable input 2. Use the **UP** and **DOWN** arrow keys to toggle through the following options. To confirm the changes press **ENTER**.

- | | |
|-------------------------|---|
| 1. DISABLE SOUNDERS – | Operation of I/P 2 will disable the sounders. |
| 2. DISABLE REM.FIRE – | Operation of I/P 2 will disable all remote fire signals. |
| 3. DIS SNDRS/REM FIRE – | Operation of I/P 2 will disable all sounders and remote fire signals. |
| 4. DISABLE BUZZER – | Operation of I/P 2 will disable all remote fire signals. |

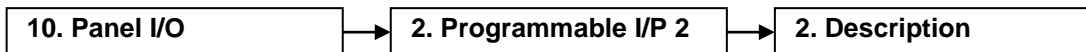

01/09/09 22:26 ENGR
EDIT PROGRAMABLE IP2
NAME: PROG I/P 2
 Press Enter Key

This option allows the engineer to change the text that will be displayed on the panel when Programmable I/P 2 is activated. This is displayed in text format and may be scrolled through by pressing the **LEFT** and **RIGHT** keys. To change the text, highlight the character to be changed and use the alphanumeric keypad to change that character. After changing a character the cursor will automatically move to the next position. To confirm the changes press **ENTER**.



01/09/09 20:13 ENGR
1.CONTROL EVENT
2.REMOTE FIRE EVENT
 Press Enter Key

This active control will allow the engineer to view or change the operation of programmable input 1. Use the **UP** and **DOWN** arrow keys to toggle through the following options. To confirm the changes press **ENTER**.

- 1. CONTROL EVENT – Operation of I/P 1 will operate a control function on the panel.
- 2. REMOTE FIRE EVENT– Operation of I/P 1 will signal a remote fire input at the control panel. Panel outputs will be triggered and fire indication will be shown at the control panel.
- 3. TECHNICAL EVENT – Operation of I/P 1 will signal a technical event at the control panel. Panel outputs will be triggered but the control panel will read technical alarm and no fire indication will be given.
- 4. DISABLEMENTS – Operation of I/P 1 will activate a disablement on the control panel.
- 5. DAY-NIGHT MODE – Operation of I/P 1 will activate the day mode on the control panel
(TWINFLEX[®] Multipoint devices will be disabled; the future TWINFLEX[®] ASD devices will be disabled for smoke only but not for heat).
- 6. PROGRAM I/P OFF – I/P 1 will not be active.



01/09/09 20:13 ENGR
1.SILENCE ALARMS
2.RESET SYSTEM
 Press Enter Key

This active control will allow the engineer to view or change the operation of the control event set for programmable input 1. Use the **UP** and **DOWN** arrow keys to toggle through the following options. To confirm the changes press **ENTER**.

- 1. SILENCE ALARMS – Operation of I/P 1 will silence the alarms.
- 2. RESET SYSTEM – Operation of I/P 1 will reset the panel.
- 3. SOUND ALARMS – Operation of I/P 1 will send the evacuate signal to the panel.
- 4. SILENCE BUZZER – Operation of I/P 1 will silence the control panel buzzer.



01/09/09 20:13 ENGR
1.REMOTE FIRE- FULL
2.REM FIRE,NO RELAYS
Press Enter Key

This active control will allow the engineer to view or change the operation of the remote fire event set for programmable input 1. Use the **UP** and **DOWN** arrow keys to toggle through the following options. To confirm the changes press **ENTER**.

- | | |
|----------------------------|--|
| 1. REMOTE FIRE FULL – | Operation of I/P 1 will signal a remote fire at the control panel. All sounders and relays will operate. |
| 2. REMOTE FIRE NO RELAYS – | Operation of I/P 1 will signal a remote fire at the control panel and only the sounders will operate. |



01/09/09 20:13 ENGR
TECHNICAL EVENT
1.LATCH 2.NON-LATCH
Press Enter Key

This active control will allow the engineer to view or change the operation of the technical event set for programmable input 1. Use the **UP** and **DOWN** arrow keys to toggle through the following options. To confirm the changes press **ENTER**.

- | | |
|----------------|--|
| 1. LATCH – | Operation of I/P 1 will signal a technical event at the control panel. All outputs will trigger and the panel will latch into fire. |
| 2. NON-LATCH – | Operation of I/P 1 will signal a technical event at the control panel. All outputs will trigger for as long as the input is activated. |



01/09/09 20:13 ENGR
1. DISABLE SOUNDERS
2. DISABLE REM.FIRE
Press Enter Key

This active control will allow the engineer to view or change the operation of the disablement event set for programmable input 1. Use the **UP** and **DOWN** arrow keys to toggle through the following options. To confirm the changes press **ENTER**.

- | | |
|-------------------------|---|
| 1. DISABLE SOUNDERS – | Operation of I/P 1 will disable the sounders. |
| 2. DISABLE REM.FIRE – | Operation of I/P 1 will disable all remote fire signals. |
| 3. DIS SNDRS/REM FIRE – | Operation of I/P 1 will disable all sounders and remote fire signals. |
| 4. DISABLE BUZZER – | Operation of I/P 1 will disable all remote fire signals. |



01/09/09 22:26 ENGR
EDIT MONITORED I/P
NAME: MON I/P
Press Enter Key

This option allows the engineer to change the text that will be displayed on the panel when Monitored I/P 1 is activated. This is displayed in text format and may be scrolled through by pressing the **LEFT** and **RIGHT** keys. To change the text, highlight the character to be changed and use the alphanumeric keypad to change that character. After changing a character the cursor will automatically move to the next position. To confirm the changes press **ENTER**.



01/09/09 20:13 ENGR
1.REMOTE SOUNDER
2.REMOTE FIRE
Press Enter Key

This active control will allow the engineer to view or change the operation of Monitored O/P 1. Use the UP AND DOWN arrow keys to toggle through the following options. To confirm the changes press **ENTER**.

- 1. REMOTE SOUNDER – Operation of O/P 1 will mimic that of a conventional sounder circuit and will de-activate on **SILENCE**.
- 2. REMOTE FIRE – Operation of O/P 1 will mimic that of a remote fire circuit and will de-activate on **RESET**.
- 3. OFF – O/P 1 will not be active.



01/09/09 22:26 ENGR
EDIT MONITORED O/P1
NAME: MON O/P 1
Press Enter Key

This option allows the engineer to change the text that will be displayed on the panel for Monitored O/P 1. This is displayed in text format and may be scrolled through by pressing the **LEFT** and **RIGHT** keys. To change the text, highlight the character to be changed and use the alphanumeric keypad to change that character. After changing a character the cursor will automatically move to the next position. To confirm the changes press **ENTER**.

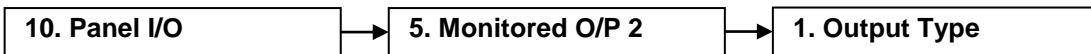

01/09/09 20:13 ENGR
1.REMOTE SOUNDER
2.REMOTE FIRE
Press Enter Key

This active control will allow the engineer to view or change the operation of Monitored O/P 2. Use the **UP** and **DOWN** arrow keys to toggle through the following options. To confirm the changes press **ENTER**.

- 1. REMOTE SOUNDER – Operation of O/P 2 will mimic that of a conventional sounder circuit and will de-activate on **SILENCE**.
- 2. REMOTE FIRE – Operation of O/P 2 will mimic that of a remote fire circuit and will de-activate on **RESET**.
- 3. OFF – O/P 2 will not be active.



01/09/09 22:26 ENGR
 EDIT MONITORED O/P2
 NAME: MON O/P 2
 Press Enter Key

This option allows the engineer to change the text that will be displayed on the panel for Monitored O/P 2. This is displayed in text format and may be scrolled through by pressing the **LEFT** and **RIGHT** keys. To change the text, highlight the character to be changed and use the alphanumeric keypad to change that character. After changing a character the cursor will automatically move to the next position. To confirm the changes press **ENTER**.

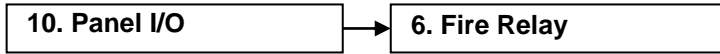

01/09/09 22:26 ENGR
 EDIT RELAY 1
 NAME: FIRE
 Press Enter Key

This option allows the engineer to change the text that will be displayed on the panel for relay 1. This is displayed in text format and may be scrolled through by pressing the **LEFT** and **RIGHT** keys. To change the text, highlight the character to be changed and use the alphanumeric keypad to change that character. After changing a character the cursor will automatically move to the next position. To confirm the changes press **ENTER**.

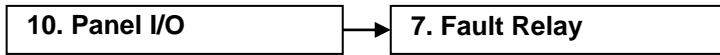

01/09/09 22:26 ENGR
 EDIT RELAY 2
 NAME: FAULT
 Press Enter Key

This option allows the engineer to change the text that will be displayed on the panel for relay 2. This is displayed in text format and may be scrolled through by pressing the **LEFT** and **RIGHT** keys. To change the text, highlight the character to be changed and use the alphanumeric keypad to change that character. After changing a character the cursor will automatically move to the next position. To confirm the changes press **ENTER**.

11. Peripheral Buss

01/09/09 22:26 ENGR
 1. PB RDU Supervise
 1. PB Comm Configure
 Press Enter Key

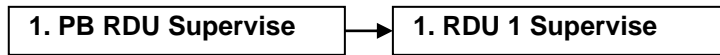

RDU 1: Disabled
 2. Disable 2. Enable
 Press <> or Esc Key

There are 8 RDUs addressed 1 to 8 that can be connected to a panel. When an RDU is enabled in RDU supervise the panel will monitor it and report it as missing if there is a cable break or loss of communications.

2. PB Comm Configure



1. View PB Baud Rate

The baud rate on the peripheral buss is fixed at 57,600 baud.

2. PB Comm Configure



2. View PB MessRate

The Message rate is fixed at a 1 second update rate.

12. Printer

The printer functions are not currently in use.

Alarm Confirmation

Introduction

The instructions in this section apply only to the Alarm Confirmation mode which is a part of the TWINFLEX[®] pro control panel and is supplementary to the rest of this manual.

The Alarm Confirmation technology has been designed primarily to address the problem of unwanted alarms in apartment blocks or 'Houses of Multiple Occupancy' (HMO).

The Alarm Confirmation facility enables certain detector alarms to be checked, or confirmed, before the entire system is activated. Furthermore, a local (at that detector) or zonal 'Alarm Confirmation Warning' sound is given, allowing any persons nearby to check the area for a possible fire. If the cause of the alarm is removed (e.g. burnt toast or a dust cloud) then the 'Alarm Confirmation Warning' will cease and the system returns to normal. If the cause of the alarm is still present at the end of the confirmation time then the entire system enters a full alarm state.

System planning prior to installation is essential, as certain zones need to be cabled separately, in order that they may be configured for 'Dwelling' (delayed) or 'Communal' (instant). e.g. The stairwell and communal corridors in a block of apartments will need to be wired on separate zones to the apartments.

If there is any doubt please refer to your supplier.

Zone Modes

Each zone on the system can be separately configured as an 'Instant' (normal) zone, or as a 'Delayed' zone. 'Instant' zones should be used for communal areas in apartment blocks and for escape routes such as stairwells, where normal fire alarm operation is detected. 'Delayed' zones introduce an 'Alarm Confirmation Delay' to a smoke or heat detector alarm on a zone, for use within apartments and other areas where unwanted alarms are likely to be a problem. Manual Call Points always give instant operation, whichever type of zone they may be a part of.

Instant Zones - Normal Operation in Communal Areas

Communal zones are those covering general access areas such as entrance hallways, corridors, stairwells etc., including any area which is an escape route for a private or dwelling area.

The activation of any Manual Call Point or detector in these areas generates an immediate alarm and operates the sounders in all areas.

The drawing below shows a typical arrangement with the communal areas highlighted. This area should be cabled on its own zone and set as an 'Instant Zone'.

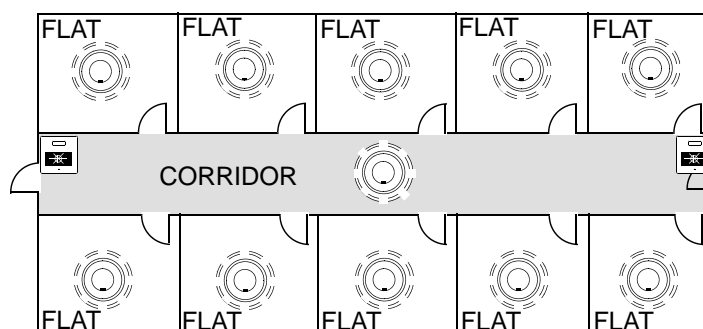

Delayed Zones – ‘Confirmation Delay’ for Dwelling Areas

Dwelling zones are those covering apartments or private living areas. The activation of any smoke or heat detector in these areas generates an ‘Alarm Confirmation Warning’ in that area but no indication shows on the control panel. The internal buzzer will sound at a very slow rate. At the end of every minute of the ‘Alarm Confirmation’ time the system will check the detector again to see if the activation has cleared. If so then the sounders will silence and no further action need be taken.

Caution – Setting a delay of greater than 1 minute is outside the scope of EN54-2.

If, however, the detector or a detector on the same zone is still activated at the end of the confirmation time, then the entire system will go into alarm, operating all the sounders on the system. The system can also be set such that any detector on any dwelling zone can confirm the alarm. The zones in confirmation can be viewed at access level 2 or 3 in the warnings menu item.

The previous drawing shows a typical arrangement with the dwelling areas shown as Bed-Sit type apartments. This area should be set as a ‘Delayed Zone’. The activation of any Manual Call Point in a delayed (communal) zone generates an immediate alarm and operates the sounders in all areas.

Delayed Zones – Local or Zonal Alarm Confirmation

Whilst a detector is in the ‘Confirmation State’ it may be configured to give an alarm confirmation warning at just that detector / sounder (Local Alarm Confirmation), or across that entire zone (Zonal Alarm Confirmation). This continues until the situation is confirmed, automatically cancelled or the panel is reset. If the device is still in fire after a reset, then a new confirmation time will start.

The drawing below shows a number of small apartments on one zone with just one Multipoint detector with sounder in each apartment. The Alarm Confirmation should be set to operate in a local manner, so that in the event of an unwanted alarm, only the one apartment is alerted.

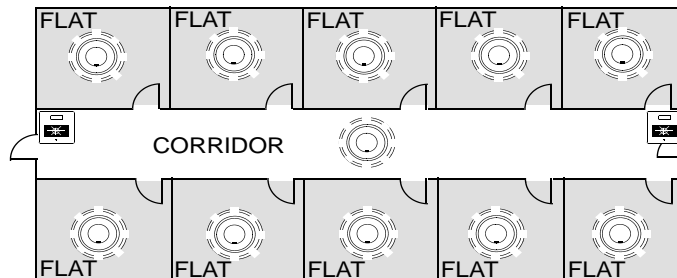

The Drawing below shows a larger apartment with several Multipoint detectors. The apartment should be cabled on its own zone and the Alarm Confirmation Alarm should be set to operate in a Zonal manner, so that all persons within the apartment are alerted.

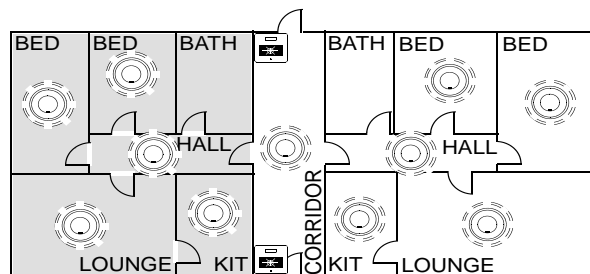

The detector DIL switch number 2 may be used to enable the ‘Logical Link’ which links the operation of the sounder to that individual detector whilst in confirmation warning stage. If this is set to the off position, the Alarm Confirmation Warning will sound in the entire zone.

		DIL SWITCH SETTINGS							
		1	2	3	4	5	6	7	8
Logical Link *	Logical link disabled (Zonal Confirmation)		0						
	Logical link enabled (Local Confirmation)		1						

Installation and Commissioning

Installation 1st Stage

The installer must install the system wiring in the form of 2-core radial circuits. The cabling should be 2 core 1.5mm², screened and fire resistant, of an MICC or FP200 equivalent type. 4 core cable as a zone in and zone out must not be used, due to the possibility of data corruption.

The zone should be left unconnected to the panel with no devices installed and must be tested for continuity and integrity with a multi-meter set to read Ohms.

The control panel back box should be mounted, with the mains supply tested, connected and isolated at the un-switched fused spur, ready for commissioning. Where the zone cabling is continued via the device, such as I/O modules, the cables should be temporarily connected through using connector blocks.

The installer needs to provide a set of 'As-Wired' drawings and proof of loop continuity and insulation test readings etc. before commissioning may proceed. This information is essential, and may be entered onto the forms provided at the rear of the manual.

Maximum Cable Lengths

Maximum cable lengths for Monitored Outputs and Monitored Input is 10 metres. For Auxiliary Power, Programmable Inputs and Fire and Fault Output relays, the maximum length is 5 metres. If a screen terminal is available then screened cable should be used. The maximum cable length for a zone is 500m.

Installation 2nd Stage

Once the commissioning engineer is satisfied with the continuity / integrity of the zone cables, the control panel may be powered up as follows:

1. Ensure that none of the field wiring is connected to the panel. This is not essential but it helps to build up the system in sections when commissioning a system for the first time.
2. Apply the 230V AC mains supply, before connecting the batteries.
3. The control panel takes approximately half a minute to boot up its processor. When this is complete, the empty zones and enabled I/O should all indicate a fault. This is correct.
4. Program the number of active zones required, and any other settings needed. This is easier and quicker using a laptop PC and the TWINFLEX[®] pro OSP software via the USB port.
5. Add a device to the end of each zone and ensure that the EOL signal is switched on in all these devices. Connect the zones into the control panel one at a time and ensure that the fault lights clear as each zone is connected (after approx 20 sec).
6. Add the additional devices in one at a time. In the case of detectors, allow each one to clear from fault (approximately half a minute).
7. Connect all other circuits and ensure that they are fault free.

There is no requirement to build the system up in sections in this manner, but we recommend this method as good engineering practice to provide a controlled process of building up the system in blocks.

Commissioning

Commissioning the TWINFLEX[®] pro system involves programming and testing the system for correct operation.

It is essential that every device is tested in every mode of operation, and that all programmed actions are observed for correct operation. This includes the smoke testing of smoke detectors, heat testing of heat detectors, testing of Manual Call Points, testing of all inputs, testing of all sounders and outputs, and fault testing of detectors by head removal.

We also recommend that all devices, which are set to 'heat only', are tested for smoke operation, to ensure that the smoke detection has been correctly disabled.

Due to the complexity and inherent importance of a life protection type system, training on this equipment is essential, and commissioning should only be carried out by competent persons.

End User Training

A Fire Alarm System is of little use if the end user and/or the responsible persons who will be present in the building do not know how to operate and respond to the system. It is therefore essential that commissioning includes training for the users of the system and responsible persons.

User instructions and a Zone Chart should be left adjacent to the control panel. As access to the system must be controlled by responsible persons, it would be unusual to display the access codes on this notice. These codes must however be available for the responsible persons, so ensure that they know and record them in a secure place.

The **TWINFLEX[®] pro User Guide** should be explained and left with the responsible person on site, for storage in an accessible and known location, in order that the responsible person and the service engineer may keep information records up to date.

A single page user instruction sheet is included at the end of this manual. A copy of this should be mounted adjacent to the control panel.

Maintenance

The CIE does not require user maintenance other than checking the log at the service interval for any spurious faults or messages and checking that all programmed functions are still valid and operational and that all devices are working correctly.

The power supply batteries should be checked for leaks or low voltages during the regular service. The service interval is to be decided by the appropriate persons but should not be more than 12 monthly.

Fault Finding

Summary of Faults

Intermittent Zone Fault

1. Tighten the unused 'zone screw terminals' at the EOL device and check all connections on the zone.
2. Too many sounders on a zone. Remove some or adjust sound levels down.
3. EOL resistor, capacitor or third party EOL device has been fitted. Remove and use the correct DIL switch on the last device.
4. Interference from old or flickering fluorescent lights, low voltage transformers etc. Ensure that the cable is screened and install a ferrite core on the zone cables. Ensure that the detector is away from light fittings and from light, especially direct or reflected sunlight.
5. Dirty or contaminated optical chambers. Replace with a new optical chamber or device.
6. Weak EOL signal. Replace the EOL device.
7. Faulty auto-calibration of EOL signal. Replace the EOL device.
8. More than one EOL. Temporarily switch off the EOL at the last device to see if the fault has cleared. If the system stays clear then another device is set to EOL and this must be found and switched off. It may be possible that more than 2 EOLs are switched on.
9. Earth fault. Ensure that all system earths are intact and not shorting to any other cables or metal.

Permanent Zone Faults

1. More than one EOL switched ON. Temporarily switch off the EOL at the last device to see if the fault has cleared. If the system stays clear then another device is set to EOL and this must be found and switched off.
2. No EOL signal detected by panel. Switch the EOL on at the last device.
3. O/C or S/C on zone cables. Remove the zone cable from the control panel and check with an electrical test meter (not a high voltage insulation test).
4. Tighten the unused 'zone screw terminals' at the EOL device.
5. Interference from old or flickering fluorescent lights, low voltage transformers etc. Ensure that the cable is screened and install a ferrite core on the zone cables. Ensure that the detector is away from light fittings and from light, especially direct or reflected sunlight.
6. Dirty or contaminated optical chambers. Replace with a new optical chamber or device.
7. Output unit with no power or no link in fault input. I/O module with no or incorrect input resistor or input EOL switch incorrectly set (switch number 6).
8. Faulty Zone at control panel (22-30 volts healthy, 1-21 volts faulty, 1 volt or less, zone switched off or short circuit).
9. Weak EOL signal. Replace the EOL device.

False Alarms

1. Dirty or contaminated optical chambers. Replace with a new optical chamber or device.
2. Incorrectly set smoke detector (smoke is not suitable for kitchens, bathrooms, boiler rooms etc., however, SM3 may be suitable outside a bathroom or kitchen but the individual situation needs to be looked at very carefully). Incorrectly set heat detector (HM1 is not suitable for kitchens, and HM3 should be kept for hotter areas such as plant rooms and commercial kitchens)
3. Faulty detector. Replace with a new one.
4. Ensure that the Optical Chamber is installed when the system is powered up, or a fault condition will be generated. This could translate into a false alarm, depending on the state of the detector.

General Faults

1. Sounder fault LED – this only activates for a fault on the conventional sounder circuit so check for O/C, S/C and 10k EOL resistor.
2. Remote Fire Output fault LED – this only activates for a fault on the Remote Fire Output so check for O/C, S/C and 10k EOL resistor. Check also that the relay used has the correct polarisation and suppression diodes installed.
3. Power fault - mains fault – Check that the 230V AC mains supply is live and the fuses are healthy.
4. Power fault, battery or charger fault – Check that the correct batteries are installed, the fuse has not blown and that the mains supply is live.
5. Earth fault. One of the circuits is connected to ground. Remove them one at a time until the relevant circuit is found, following which an electronic test meter may be used to track the problem.

Finding Zone Faults

A fault on a zone of the TWINFLEX[®] pro system may be found as follows:

1. In order to prove whether the fault is control panel based or in the field (including the field wiring), swap the wires from the zone in fault with those in a clear zone (active but no fault) at the control panel.

If the fault moves with the wiring then the fault is in the field. If the fault stays on the same zone then the fault is in the control panel.

2. Examine the LEDs carefully for signs of the fault as follows:

If the buzzer has been silenced, create another fault to cause it to return, e.g. remove a battery lead until the buzzer starts again.

Multipoint LED action	Reason
20 second flash	The detector is operating normally and is not set to EOL.
20 second dual flash	The detector is operating normally, is set as heat only and is not set to EOL (future ASD Detector only).
5 second flash	The detector is operating normally and is set to EOL.
1.5 second flash	The detector is in fault. Check for dust contamination and that the optical chamber is locked on correctly.
0.3 second flash or continuous	The detector has triggered into the fire state and is not yet reset. Check for smoke and contamination.

Manual Call Point LED action	Reason
No LED	The MCP is operating normally, or is not powered at all. Test the MCP to clarify.
5 second flash	The MCP is operating normally and is set to EOL.
0.3 second flash	The MCP has triggered into the fire state and is not yet reset.

3. If steps 1. and 2. do not clarify the matter then split the zone wiring at a suitable mid point, removing the outgoing cables from the terminals completely, and then setting the EOL switch to the on position before reassembling that device.

If the fault clears then it is after that point, but if the fault persists then it is before that point.

The split may then be moved in the relevant direction, halving the remaining devices, and the procedure repeated until the fault is found.

Advanced Connections

Magnetic Door Hold Units

If magnetic door hold devices are required, it is recommended that they are connected as shown in the upper right diagram. This is suitable if it is convenient to cable to the control panel.

An Input/Output module may also be used for this operation, in which case a relay would not be required.

We recommend the use of 24V DC Magnetic Door Hold units, in order to enable them to operate from a power supply with a battery standby. This ensures normal operation in the event of an interruption to the power supply.

For assistance in choosing a suitable power supply unit, standby batteries, and Magnetic Door Hold units please contact your supplier.

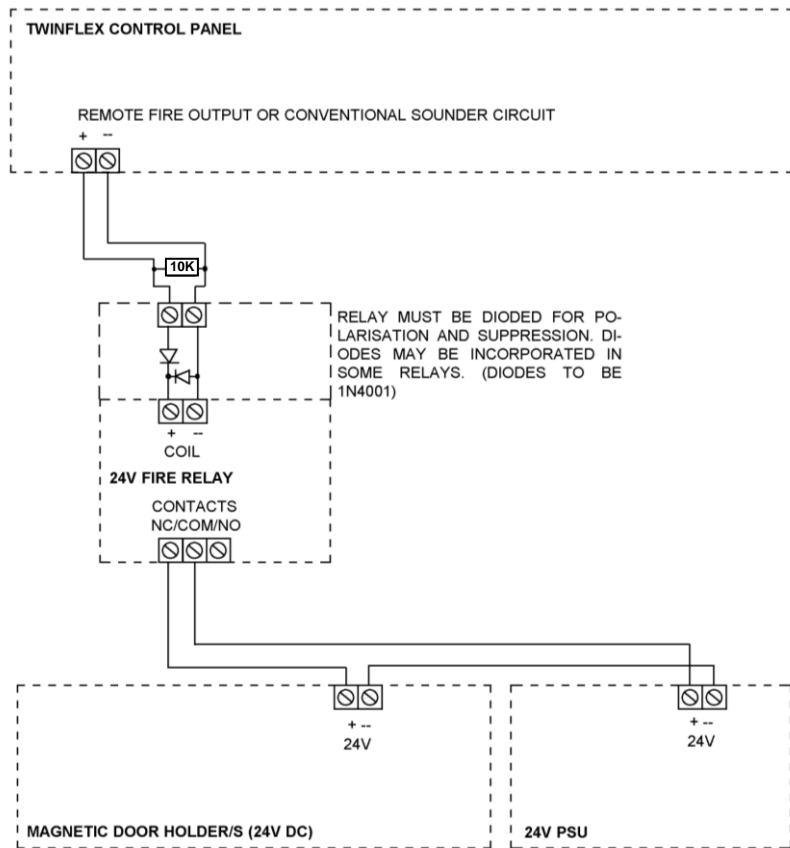

Connecting Two Panels Together

Only a maximum of two panels should be connected in this way.

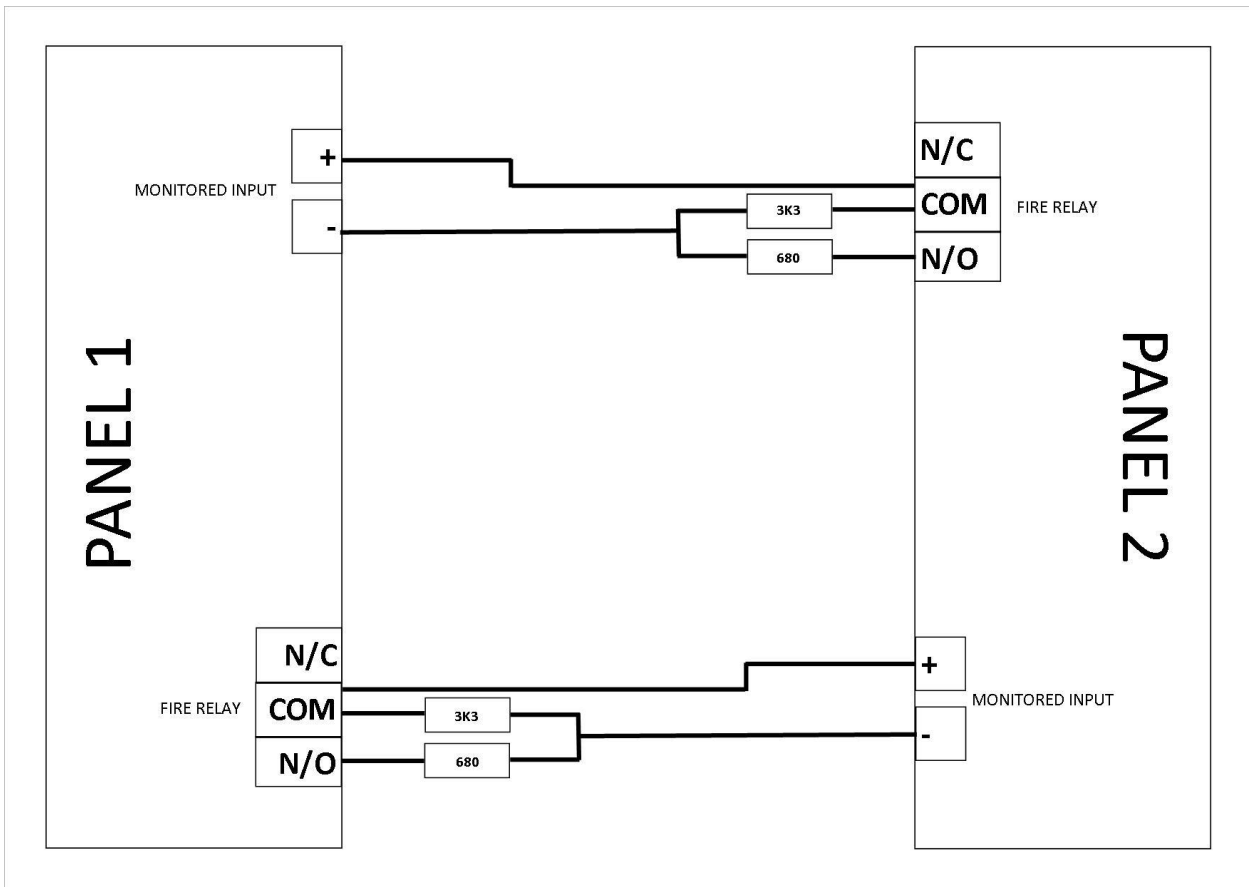

For each panel, configure a monitored input as a remote fire event as follows:
Monitored inputs on panels 1 and 2 should be set to remote fire event with no relay activation.



01/09/09 20:13 ENGR
1.CONTROL EVENT
2.REMOTE FIRE EVENT
Press Enter Key

This active control will allow the engineer to view or change the operation of programmable input 1. Use the **UP** and **DOWN** arrow keys to toggle through the following options. To confirm the changes press **ENTER**.

2. REMOTE FIRE EVENT-

Within this option select option 2. Rem Fire, No Relay. Operation of the Monitored I/P will signal a remote fire input at the control panel. Panel outputs will be triggered and fire indication will be shown at the control panel but the relays will not operate.

This will allow the fire condition to be reset from the panel that reported the fire. If the relays were set to operate then the fire condition would be re-triggered after a reset.

Connecting four Panels Together

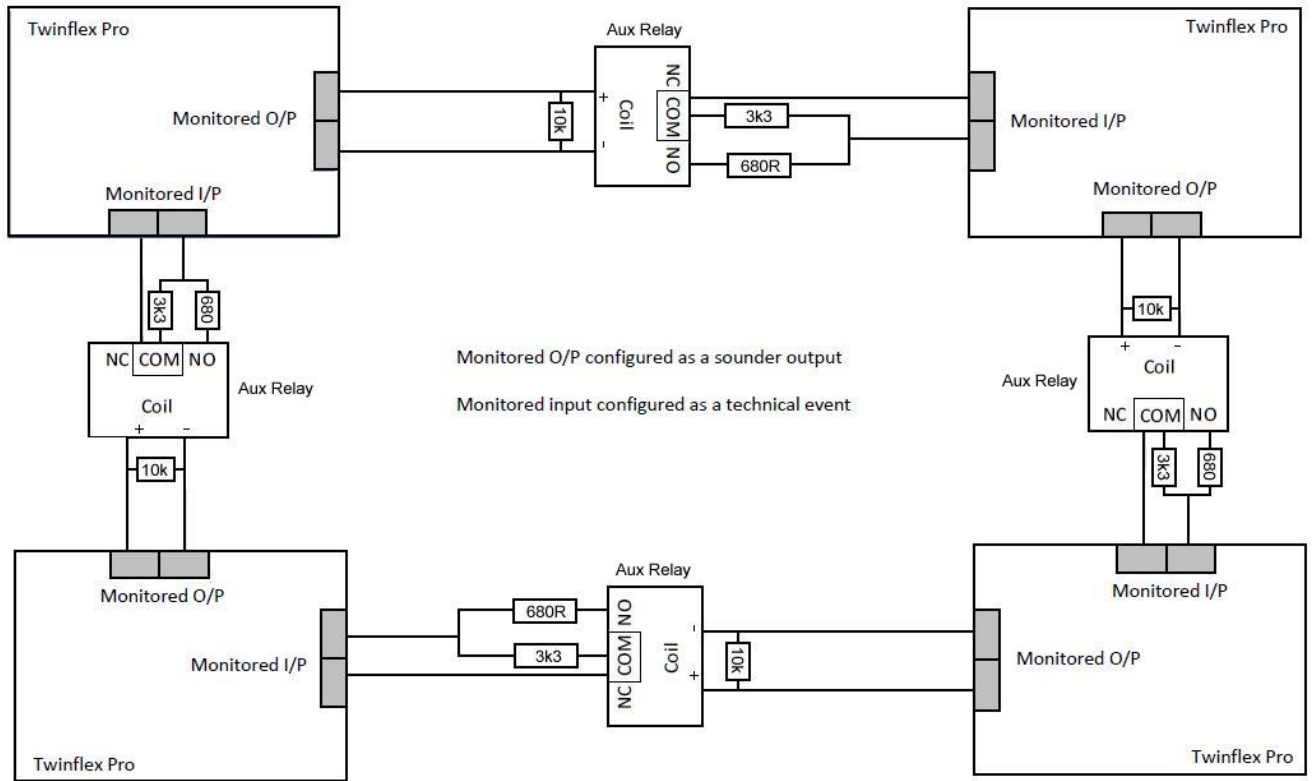

01/09/09 20:13 ENGR
1.CONTROL EVENT
2.REMOTE FIRE EVENT
 Press Enter Key

This active control will allow the engineer to view or change the operation of the programmable input. Use the **UP** and **DOWN** arrow keys to toggle through the following options. To confirm the changes press **ENTER**.

3. TECHNICAL EVENT – Operation of the Monitored I/P will signal a technical event at the control panel. Panel outputs will be triggered but the control panel will read technical alarm and no fire indication will be given.

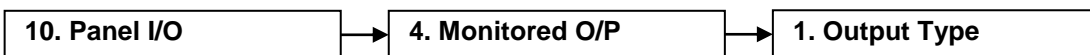

01/09/09 20:13 ENGR
1.REMOTE SOUNDER
2.REMOTE FIRE
 Press Enter Key

This active control will allow the engineer to view or change the operation of a Monitored O/P. Use the UP and DOWN arrow keys to toggle through the following options. To confirm the changes press **ENTER**.

1. REMOTE SOUNDER – Operation of a Monitored O/P will mimic that of a conventional sounder circuit and will de-activate on **SILENCE**.

Connecting Two TF Pro Panels & one TF V3 Panel Together

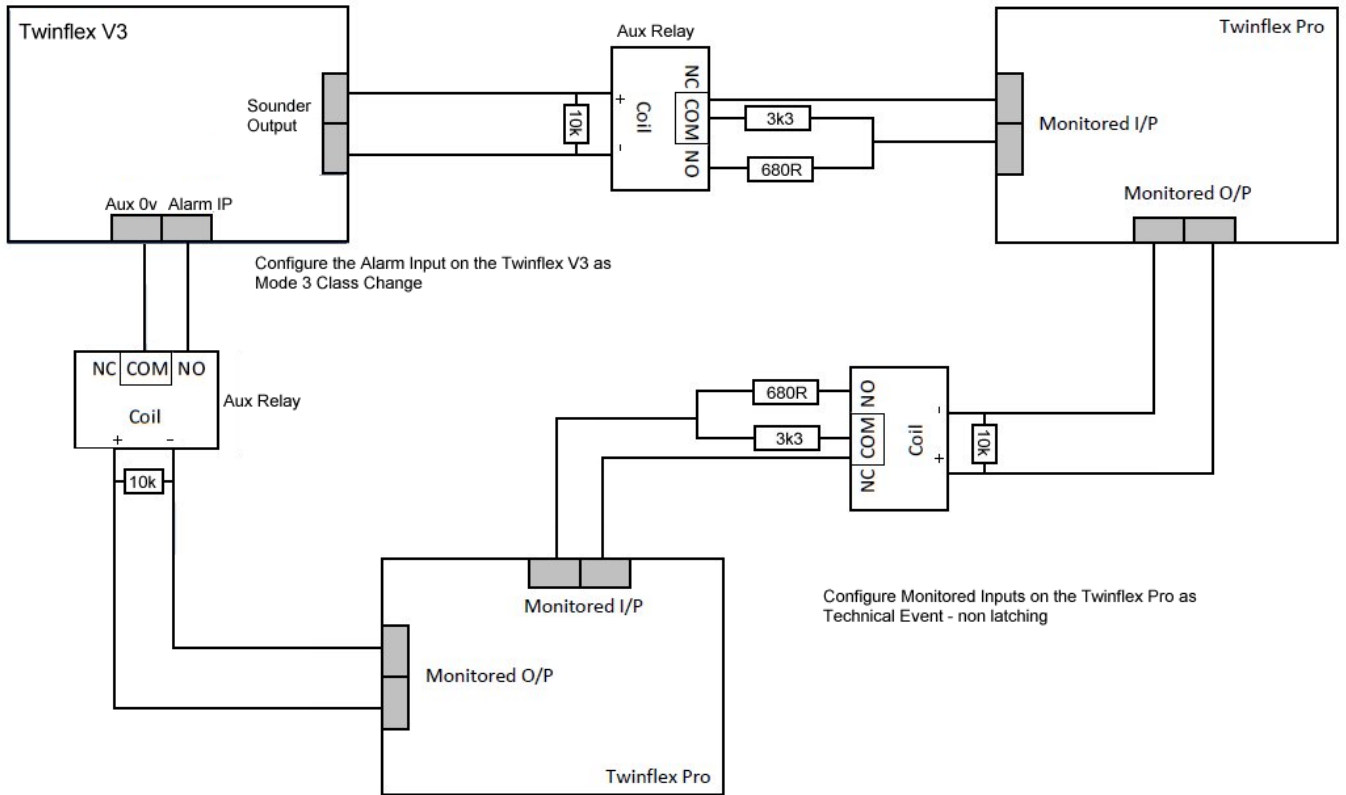

Peripheral Bus Connections

Communications between the panel and repeater is via a multi-drop RS-485 Peripheral Bus. 2-core 1.5mm² screened fire resistant cable (i.e. FP200, Firetuff, Firecell, Lifeline or equivalent) cable should be used for communications to the repeater and connected to the back board.

The maximum total cable length from the control panel to a repeater is 500 metres. Up to 8 repeaters can be used but they must all be within the maximum 500 metres cable length and are wired A to A, B to B, Screen to Screen and so on up to the maximum of 8 repeaters. The peripheral bus must be run from the panel to the first repeater then the second repeater and so on; the peripheral bus must not be spurred from one point.

Peripheral Bus Connection Table

Control panel	First Repeater panel	Second Repeater panel
NET A	A	A
NET B	B	B
SCRN	Screen	Screen

There are two sets of peripheral bus connections on the panel. These are linked in the panel so either set can be used. A 120Ω terminating resistor must also be fitted across NET A & NET B at the panel.

Example of Panel Peripheral Bus Connections Showing EOL Resistor

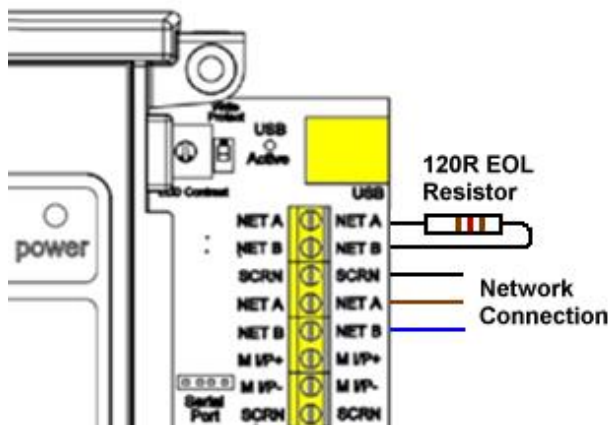

On the repeater a 120Ω terminating resistor must also be fitted across A and B but only on the last repeater on the network.

Peripheral Bus Settings

NOTE: The panel should be set to a number in the range of 10 to 99 when using repeaters. This is done by logging onto Engineers Mode and selecting option 9 Panel Details, then select option 4 PNL Identification, then option 1 Panel Number. The write Enable switch will need to be on for changes to take place.

To setup the panel to use repeaters, log into Engineers Mode and select Option 3 Enable / Disable, then option 5 Peripheral Bus and set the peripheral bus to ON.

From the main Engineers Menu select option 11 Peripheral Bus, within this select:

Option 1 PB RDU Supervise. In this option there is a list of 1 – 8 repeaters, (RDUs). Enable the repeater(s), (RDUs) that are being used and are connected to the panel. This will enable the panel to monitor the repeaters and report them as missing if there is a cable break or loss of communications.

When this is done press ESC to go back into option 11 Peripheral Bus, then do a panel reset. The panel should now be setup for the repeater(s).

Note: If RDU addresses are enabled that are not connected to the panel, the panel will report them as "Missing".

Technical Data

Control Panel Specification

	2 Zone Panel	4 Zone Panel	8 Zone Panel
Dimensions (mm)	331 x 331 x 99		
Weight (excluding batteries)	2.25 kg	2.28 kg	2.36 kg
Construction	V0 rated ABS		
IP Rating	IP 30		
Cable Entry	13 x 20mm knockouts 1 x 50mm x 50mm pull out tab		
Cable type	2 core 1.5mm ² screened fire rated cable, 500m (max per zone)		
Detection zones	2 Max	4 Max	8 Max
Devices per zone	Up to 32 Devices dependant on Device Loading Units (DLUs) not exceeding the stated maximum loading.		
Device Protocol	TWINFLEX® V3 + TWINFLEX® pro		
Monitored sounder circuits	Up to 2		
Monitored relay circuits	Up to 2		
Relays on board	Common fire and common fault		
Operating standard	BS EN54-2 & 4		
Operating temperature	5°C to 40°C		

Control Panel Ratings

	2/4/8 Zone Panel
Mains voltage	230V AC Nominal 700mA
PSU output (4 hour continuous)	2.1A
Operating voltage	Nominal 24V DC (Range 21-31V DC)
Battery charger output	170 mA Max
Charger high impedance voltage	<4V DC
Battery voltage (During Charge)	27.3 V DC @ 20°C
Battery capacity	2 x 12V 3.2Ah (or 3.3 Ah) or 2 x 12V 3.2 Ah, Max load 1.8A
Maximum Internal resistance including connections and Fuse	1R
Zone output (max)	160 mA
Zone voltage (nominal)	30V DC
Sounder output load (max, fused)	300 mA trip polyfuse
Sounder output EOL	10k
Remote fire output load (mon relay)	300 mA trip polyfuse
Remote fire output EOL (mon relay)	10k
Monitored Outputs 1 and 2 DC supply Current (max)	250 mA for a 2 – 4 zone panel 200mA for an 8 zone panel
Auxiliary DC supply Current (max)	250 mA
Auxiliary DC supply Volts, Unregulated	21V – 31V DC
Common fire relay	Volt free SPCO contacts 1A 30V max
Common fault relay	Volt free SPCO contacts 1A 30V max
Loading	160 DLUs max per zone
Imin (Required by EN54-4)	30mA
Imax.a (Required by EN54-4)	185mA

Control Panel Fuses and Protection

	2 Zone Panel	4/8 Zone Panel
Zone output	300 mA trip polyfuse	
Sounder output	300 mA trip polyfuse	
Remote fire output (mon relay)	300 mA trip polyfuse	
Auxiliary 24V DC supply	300 mA trip polyfuse	
Mains	T4A Time Delayed 20mm Ceramic (in mains terminal block)	
Battery Charger	170 mA current limiter	
Battery (reverse polarity)	3.15A F 20mm (in line with battery leads) Glass	

Note: Refer to the relevant sections in the manual for full details of input and output ratings

Battery Calculations

Where: IS = Standby Current, IA = Alarm Current, MP = Multipoint Detector

Note: An Excel spreadsheet (document no. 26-1116) is also available to automatically work out both standby battery calculations and zone loading calculations based on the quantities entered.

Item	QTY	IS (mA)	Tot IS (mA) =QTY x IS (mA)	IA (mA)	Tot IA (mA) =QTY x IA (mA)
TWINFLEX [®] pro 2-Zone Panel		12.000		12.000	
TWINFLEX [®] pro 4-Zone Panel		26.000		26.000	
TWINFLEX [®] pro 8-Zone Panel		30.000		30.000	
Multipoint no sounder		0.114		1.500	
Multipoint sounder – Low		0.114		3.500	
Multipoint sounder – High		0.114		8.500	
MCP no sounder		0.050		0.050	
MCP with sounder – Off		0.185		1.998	
MCP with sounder – Low		0.185		12.619	
MCP with sounder – High		0.185		14.500	
Flashpoint – Beacon Only		0.223		5.520	
Flashpoint – Low		0.223		15.002	
Flashpoint – High		0.223		23.515	
Soundpoint – Low		0.185		12.619	
Soundpoint – High		0.185		14.500	
Hipoint – Low		0.185		12.619	
Hipoint – High		0.185		14.500	
Hatari Sounder		0.092		10.056	
Output Module (powered from panel) *	0	5.092		34.130	
Output Module (externally powered) *	0	0.914		2.449	
Input/Output Module		0.207		22.715	
No. of Zones in Use (EOL in standby)		0.500		0.000	0.000
No. of Detectors Activated		0.000	0.000	48.500	
No. of MCPs Activated		0.000	0.000	16.000	
Current Drawn from Aux 24V O/P – (up to 250mA) Enter total mA for standby and for alarm		?		?	
Current Drawn from Remote Alarm O/P – (up to 250mA) Enter total mA for alarm		0.000	0.000	?	
Current Drawn from Bell O/P – (up to 250mA) Enter total mA for alarm		0.000	0.000	?	

ADD

Totals
Times (hrs)
Current required (mAh)
Total Current (mAh) without backlight
Add: LCD Backlight for 20 minutes during alarm (44mA / 3)
Total Current (mAh) with backlight
Total Current (Ah)
Battery requirement (Ah)

IStot (mA) A		IAtot (mA) B	
Standby (hrs) C		Alarm (hrs) D	
IS (mAh) E		IA (mAh) F	
		E + F = G	
		H	14.52
		G + H = I	
		I / 1000 = J	
		J x 1.25 = K	

* The Twinflex Output Module is not compatible with the TwinflexPro panel. Please use the Twinflex I/O Module with this panel.

Installation Checklist

Use the following checklist to ensure that your work is correct and that the commissioning engineer has the necessary information to complete the commissioning of the system

If you require a commissioning visit, the engineer will require this sheet, along with 'Zone Continuity and Insulation Test Results' and correctly marked 'as-wired' drawings, before attending site to commission the system.

Stage 1

Description	Installation Engineer Checked	Commissioning Engineer Checked
Zone cables installed correctly, clipped or in containment.		
All device bases and back boxes installed and terminated.		
Cable insulation and continuity testing complete, and form filled out.		
As-wired drawing marked up showing cable runs and devices.		
Control panel back-box installed with 230V AC supply live, tested and isolated locally		

Stage 2

Depending on the terms of your contract, you may also be required to carry out 'Stage 2'.

Description	Installation Engineer Checked	Commissioning Engineer Checked
Devices installed into bases and back-boxes		
Detector dust covers fitted		

Site Name & Address:	
Installation Company:	
Testing Engineer:	
Signature:	
Date:	

Commissioning Checklist

The following checklist may be used to ensure that all steps are taken. This is not a BS5839 certificate and serves as a reminder only and may need additional items added to suit your working practices.

Step 1

Description	Commissioning Engineer Checked
Panel powered up (230V AC Mains first, then batteries). Nothing else connected. All zones showing fault.	
Program the number of 'Active' zones required, check that zones not required are clear of fault.	
Low voltage multimeter test of cables to show no inter-core short circuits.	
End of Line device installed with EOL switch in the ON position and remainder of devices added with DIL switches set, then each zone connected with approx 30 - 50 secs allowed to clear fault condition.	
All faults (device, input, output, EOL, battery, etc,) cleared from control panel.	

Step 2

Control panel programmed for any additional features.	
All other cables connected and clear of fault.	

Step 3

Correct operation of all input devices tested, ie. detectors, manual call points and inputs.	
Correct operation of all output devices tested, ie. sounders, relays and outputs.	
Correct operation of all programmed actions tested, ie. instant alarms, confirmation alarms, two stage alarms.	

Step 4

System Manuals completed, zone chart or zone list displayed.	
End user or responsible person trained and user manual issued.	

Site Name & Address:	
Commissioning Company:	
Commissioning Engineer:	
Signature:	
Date:	

Cable Continuity & Insulation Test Results

After installation of the cable, and termination into all the relevant back-boxes, install a wire link between the zone +ve and –ve connections at the last device in order to be able to take cable continuity readings, removing it to take insulation readings. Make sure that all the cables are dressed smoothly and neatly into their back-boxes in order that they will not be disturbed after the readings are taken.

The commissioning engineer will require these readings, along with correctly marked 'as-wired' drawings, before attending site to commission the system.

Core	Continuity Reading (ohms)							
	Z1	Z2	Z3	Z4	Z5	Z6	Z7	Z8
Zone +ve to –ve with a temporary link at the last device.								
Others . .								

A reading of approximately 1 ohm per 100 metres of 1.5 mm² cable is expected and any significant variation from this should be investigated. If the above readings are satisfactorily showing circuit continuity then you may also take the reading below, remembering to remove your temporary link at the last device.

Core	Insulation Reading (M ohms)							
	Z1	Z2	Z3	Z4	Z5	Z6	Z7	Z8
+ve to -ve								
+ve to Earth								
-ve to Earth								
Screen to mains Earth: with scrn disconnected from panel								
Others . .								

A reading in excess of 1M ohm is expected and any significant variation from this should be investigated. If the readings are satisfactory then the zone wiring is largely proven other than for faults such as complete polarity reversal.

Site Name & Address:	
Installation Company:	
Testing Engineer:	
Signature:	
Date:	

FIRE ALARM SYSTEM NOTICE

To Enable the Control Panel Keys

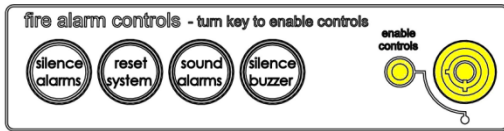

You may gain access to the fire alarm controls by inserting the key turning ¼ turn or by entering the USER code (default 8737). The 'Controls Enabled' LED should then be illuminated. If, after entering the code, further action is not taken, the 'Controls Enabled' light will eventually time out.

To disable the control panel keys, turn the key switch off. When disabled, the 'Controls Enabled' LED should then be extinguished. If a code was used, press 'ESC' to return to normal operation.

To prevent unauthorised operation, the controls should be kept disabled and the key/code kept secure under the control of the responsible person.

To Manually Operate the Fire Alarm Sounders



Enable the controls and then press 'SOUND ALARMS'.

To silence the alarm sounders press 'SILENCE ALARMS'.

Following a Fire Alarm Operation



The red 'FIRE' LED will illuminate. The fire alarms and the internal buzzer will operate as programmed. Take appropriate action as defined by the emergency plan for the premises.

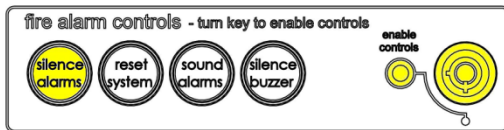

To silence the alarm press 'SILENCE ALARMS', then establish the cause of the alarm and enter the details in the log book.

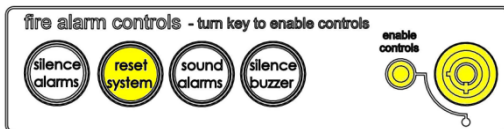

Reset any Manual Call Points which may have been operated, or if a detector has been operated be sure that the cause of the alarm has been removed, before resetting the system by pressing 'RESET SYSTEM'.

Following a Fault Condition



The appropriate fault LEDs will illuminate. The internal buzzer will sound. To mute the internal buzzer press 'SILENCE BUZZER'. Investigate and rectify the appropriate fault (competent persons). Once the fault has been rectified the fault indication will clear automatically.



Important Notes

FIRE ALARM COMPANY:

ADDRESS:

FOR SERVICE CALL:

(Working hours)

(Call Out)

FIRE ALARM USER NOTICE

Note

The Fire alarm system installed in this building has 'Alarm Confirmation' technology to help eliminate false alarms.

Please read and understand the following information in order to make the most use of the system.

Operation

When the detector within your area activates it will initially only operate the sounders within your own area for a predetermined 'Confirmation' time.

At the end of the 'Confirmation' time the system will check the detector again to see if the activation has cleared. If so, the sounders will silence and no further action need be taken.

If, however, the detector is still activated, the entire system will go into alarm, operating all the sounders on the system.

Action Required

If you think that you may have accidentally set off the fire alarms, then check the following:

If the fire alarm within your area only is sounding, then check your own area for the cause of the alarm. If this proves to be a false alarm due to dust, cooking fumes, steam, cigarette smoke, etc, then clear the smoke from the area in order to allow the system to reset itself after a few minutes. If this happens then no further action is required. If the fire alarms in the communal areas are also sounding, then follow the building's fire procedures for evacuation.

If you discover a genuine fire, then follow the building's fire procedures for evacuation, activating the nearest Fire Alarm manual call point on the way out if the alarms are not already sounding.

Do not attempt to put out the fire unless it is safe to do so.

Further Information

Further information will be located adjacent to the Main Fire Alarm Control Panel, or may be obtained from either the person responsible for building maintenance or from the Fire Alarm Company responsible for maintaining the Fire Alarm System.

Confirmation Time before full alarm :- Minutes

APARTMENT NOTICE FOR SYSTEMS USING ALARM CONFIRMATION

Engineers Notes

Engineers Notes

Technical Support

Contact your distributor for technical support on this product.

Do not call the Fike Safety Technology technical support department unless your distributor has first given their advice and attempted to rectify the issue.

Technical support will not be available if the instruction manual has not been read and understood. Please have this instruction manual available whenever you call for technical support.

 0832	
Fike Safety Technology Ltd Unit 31, Springvale Ind. Est. Torfaen, NP44 5BD 11 DoP-505-0002, DoP-505-0004, DoP-505-0008	
EN54-2: 1997 +A1: 2006, EN54-4: 1997 +A1: 2002 +A2: 2006 505-0002,505-0004,505-0008 Intended for use in the fire detection and fire alarm Systems in and around buildings	
Essential characteristics	Performance
Operational reliability	Pass
Durability of operational reliability and response delay, Temperature resistance	Pass
Durability of operational reliability, Vibration resistance	Pass
Durability of operational reliability, Humidity resistance	Pass
Durability of operational reliability, Corrosion resistance	Pass
Durability of operational reliability, Electrical stability	Pass
Performance under fire conditions	Pass
Response delay (response time to fire)	Pass
Performance of power supply	Pass