

/ Installation guideline Explosion Isolation Valve VENTEX® ESI

For VENTEX ESI-E /-D and -C with housing material in mild steel and stainless steel

/ Function diagram VENTEX ESI-E & VENTEX ESI-D

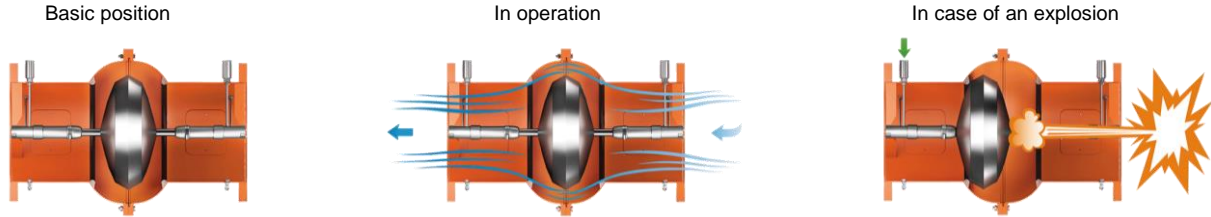

/ Function diagram VENTEX ESI-C

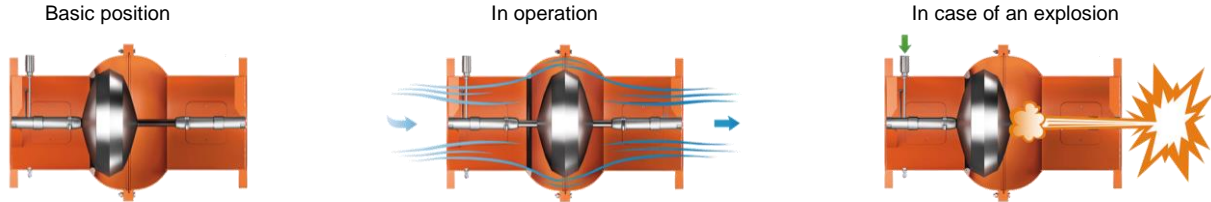

/ In case of an explosion, the pressure wave pushes the closing device (without external energy supply) against the valve gasket.
 / The valve is locked in this closed state, preventing the spread of flames and pressure waves.

/ Certified for

Zone inside: Certificate CE₀₀₈₁Ex II 1GD IIB / Zone 0, 1, 2, 20, 21, 22

Zone outside: The outside zone is depending on the execution of the mounted parts (e.g. Switch, )

/ Description

Function	Installation position			
	horizontal		Vertical	
			Explosion from top	Explosion from bottom
single acting	VENTEX ESI-E		VENTEX ESI-EO	VENTEX ESI-EU
double acting	VENTEX ESI-DV			
check valve with locking fuinction	VENTEX ESI-C		VENTEX ESI-CO	VENTEX ESI-CU



/ Technical data

The data for air speed 20m/s and 25m/s applies to optimal conditions. See the description of the optimal conditions on page two.
 Maximum air speed in the opposite direction than the explosion direction for VENTEX ESI-E and VENTEX ESI-C = 35m/s

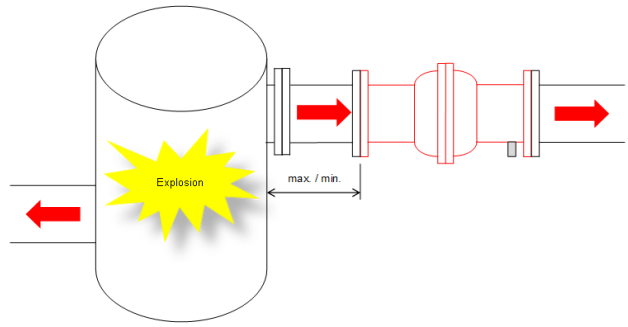

	Nominal diameter													
	DN100		DN150		DN200		DN300		DN400		DN500		DN600	
Type	6		6		6		6		6		6		6	
Certificate number FSA (year) ATEX (no.)	12/1622X		12/1623X		12/1624X		12/1625X		12/1626X		12/1627X		14/1646X	
max. air speed	m/s	20	25	20	25	20	25	20	25	20	25	20	25	
Explosion pressure	min. bar(g)	0.05	0.05	0.05	0.05	0.05	0.05	0.05	0.05	0.05	0.12	0.05	0.06	0.2
	at 20°C max. bar(abs)	14	14	14	14	14	14	14	14	14	14	14	14	13
Organic dust up to K-Value 300														
max. K-Value	bar x m x s ⁻¹	300	300	300	300	300	300	300	300	300	300	300	300	300
Installation distance	min. m	3	3	3	3	3	3	3	3	3	4	3	4	5
	max. m	12	12	12	12	12	12	12	12	12	12	12	12	12
Organic dust K-Value 301 to 400														
max. K-Value	bar x m x s ⁻¹	400	400	400	400	400	400	400	400	400	400	400	400	400
Installation distance	min. m	3	3	3	3	3	3	3	3	4	4	3	---	5
	max. m	5	5	5	5	5	5	5	5	6	6	3	---	5.2
Gas, Gas group IIB														
max. K-Value	bar x m x s ⁻¹	100	100	100	100	100	100	100	100	100	100	100	100	100
Installation distance	min. m	3	3	3	3	3	3	3	3	3	4	3	4	3.85
	max. m	8	8	8	8	8	8	8	8	8	8	8	8	8
Hybride mixtures														
max. K-Value	bar x m x s ⁻¹	400	400	400	400	400	400	400	400	400	400	400	400	(100) 430
Installation distance	min. m	3	3	3	3	3	3	3	3	4	4	3	---	(3.85) 3.85
	max. m	5	5	5	5	5	5	5	5	6	6	3	---	(8) 5.2
Metallic dust (Aluminium)														
max. K-Value	bar x m x s ⁻¹	400	400	450	450	450	450	450	450	---	---	300	300	300
Installation distance	min. m	3	3	3.1	3.1	4	4	4	4	---	---	5.2	5.2	4.85
	max. m	3.5	3.5	5.1	5.1	5	5	5	5	---	---	5.4	5.4	6.15
VENTEX ESI-C only as pressure barrier (no flame barrier)	min. m	1	1	1	1	1	1	1	1	1	1	1	1	1

/ Installation guideline Explosion Isolation Valve VENTEX® ESI

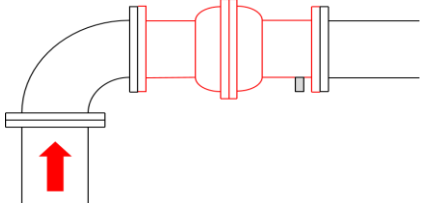
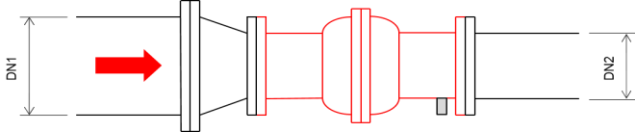
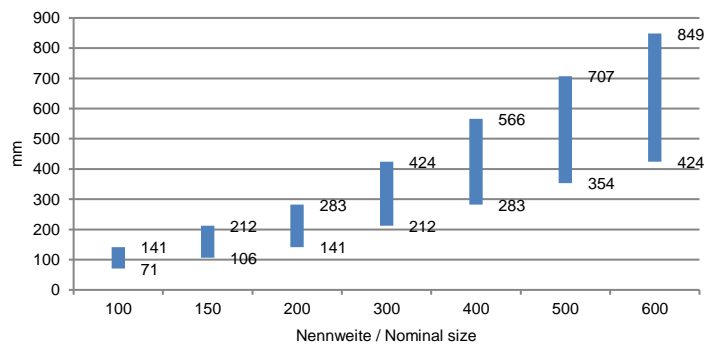
/ Requirements on the installation situation

Installation situation	Requirements and notes
Providing of the functionality in case of an explosion (the valve must close) Important: The requirements in case of an explosion have priority compared to the requirements for normal operation.	
Min./max. installation distance must be measured from the wall of the vessel to the flange of the VENTEX® valve.	
Operating temperature > +90°C	Reduces the max. allowed explosion pressure. See details in the technical data sheet of the valve. 
Pipe elbow in front of the valve in explosion direction	Does not influence the minimum needed explosion pressure. 
Change of the nominal diameter (DN) in front of the valve in explosion direction	Influences the explosion pressure. (Attention: take account of burst strength/resistance and minimum required explosion pressure of the valve). If the nominal diameters of the pipe and the valve are different the cone has to be mounted directly in front of the valve. Recommended cone $\le 16^\circ$.
Max./min. allowed change of the nominal diameter (DN) in explosion direction	The maximum allowed deviation between the nominal diameters (DN) is double cross-section surface.  

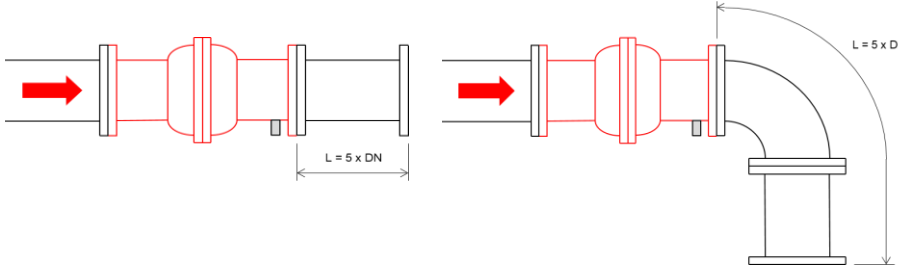
/ Installation guideline Explosion Isolation Valve VENTEX® ESI

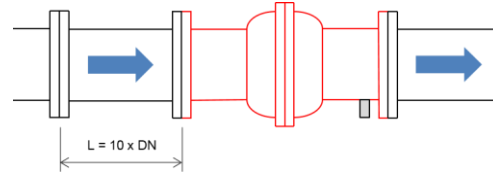
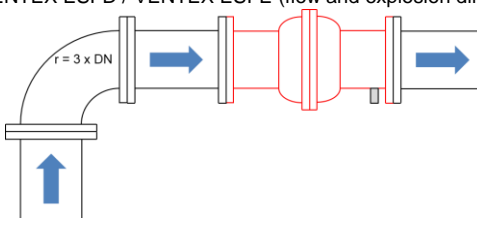
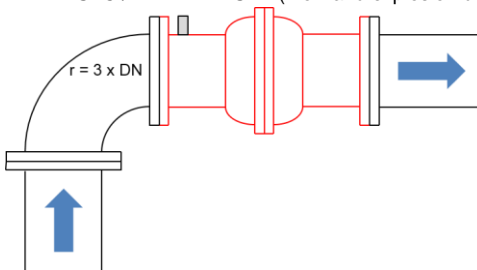
Installation situation	Requirements and notes	
Providing of the functionality in case of an explosion (the valve must close)		
Important: The requirements in case of an explosion have priority compared to the requirements for normal operation.		
Change of the nominal diameter (DN) after the valve in explosion direction	After the valve, the length of the pipe (min. PN1) has to be at least fivefold of the nominal diameter of the valve (5 x DN). 	
Allowed dust loading	Limit values for operation (obligatory): / air speed > 12 m/s / particle size < 0.5 mm / dust concentration < 50 g/m ³ / dry air and no condensate / VENTEX ESI-C allows no dust loading	No dust deposits are allowed which might prevent the tight closing of the valve. Danger exists due to the combination of dust and condensate. 
Installation situation		
Providing of functionality in normal operation (valve must not close)		
Maximal allowed volume/air speed	The max. volume flow contained in the technical data sheet must be observed and can only be achieved under optimum conditions.	
Pipe in front of the valve in process direction	In front of the valve in flow and explosion direction, the length of the straight pipe has to be at least tenfold the nominal diameter the valve (10 x DN). VENTEX ESI-D / VENTEX ESI-E (flow and explosion direction are identical) 	
Elbow in front of the valve in operation/process direction	The mean arc radius (r) of the elbow has to have at least the triple size of the nominal diameter (3 x DN) of the valve. Smaller arc radiuses reduce the maximum achievable air speed. VENTEX ESI-D / VENTEX ESI-E (flow and explosion direction are identical)  VENTEX ESI-C / VENTEX ESI-E (Flow and explosion direction against each other) 	

/ Installation guideline Explosion Isolation Valve VENTEX® ESI

/ Dimensions

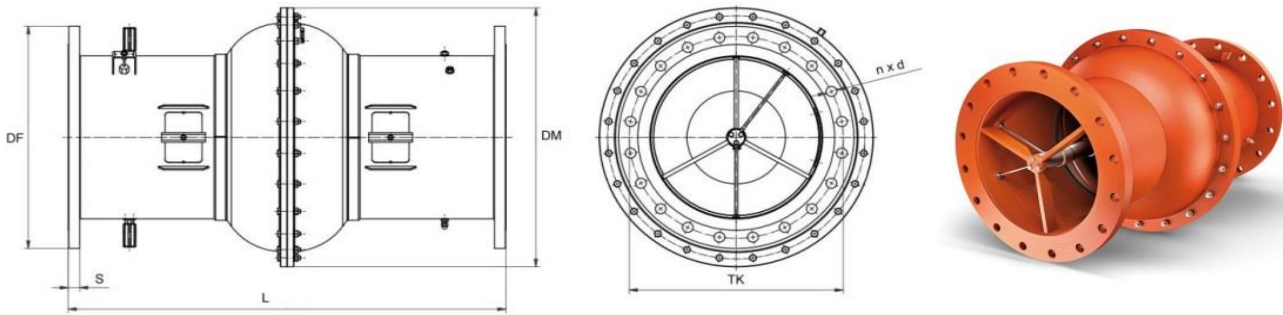

		Nominal diameter						
		DN100	DN150	DN200	DN300	DN400	DN500	DN600
Dimensions of flanges according DIN 1092-1								
Length	L	E:350, D:400	500	610	780	940	1300	1420
∅ Middle flange	DM	215	315	417	550	682	814	929
∅ Connecting flange	DF	220	285	340	445	565	670	780
Thickness flange	S	22	24	24	26	32	36	36
Circle-∅	TK	180	240	295	400	515	620	725
Quantity x ∅ Hole	n x d	8 x 18	8 x 22	8 x 22	12 x 22	16 x 26	20 x 26	20 x 30
Dimensions of flanges according ANSI #150								
Length	L	E:350, D:400	500	610	780	940	1300	1420
∅ Middle flange	DM	215	315	417	550	682	814	929
∅ Connecting flange	DF	228.6	280	343	483	597	698.5	812.8
Thickness flange	S	20	25.4	24	26	32	36	36
Circle-∅	TK	190.5	241.3	298.4	431.8	540	635	749.3
Quantity x ∅ Hole	n x d	8 x 19	8 x 22	8 x 22	12 x 22	16 x 28.6	20 x 32	20 x 34.9
Weight								
Weight (net)	ca. kg	30	35	53	84	133	213	305
Weight (gross)	ca. kg	34	43	61	94	153	241	354

RICO Sicherheitstechnik AG reserves the right to make technical changes or modify the contents of this document without prior notice.