

# FIK-IM-10 Ten Input Monitor Module

704 SW 10th Street  
Blue Springs, MO 64015  
Phone: 816.229.3405; Fax: 816.228.9277  
[www.fike.com](http://www.fike.com)

**SPECIFICATIONS**

Normal Operating Voltage:	15-32 VDC
Stand-By Current:	3.75 mA @ 24V
Alarm Current:	55 mA (assumes all ten LEDs solid on)
Temperature Range:	32°F to 120°F (0°C to 49°C)
Humidity:	10 to 93% Non-condensing
Dimensions:	6.8" H x 5.8" W x 1.25" D
Accessories:	FIK-BB-2 Cabinet and Chassis
Wire Gauge:	12-18 AWG
Maximum IDC	
Wiring Resistance:	1500 Ohms
Maximum IDC Voltage:	10.2 VDC
Maximum IDC Current:	240 µA (each circuit)

For system/product documentation including installation, operation, and maintenance, scan QR code or enter URL provided.



<http://www.fike.com/06-912>

**BEFORE INSTALLING**

If the modules will be installed in an existing operational system, inform the operator and local authority that the system will be temporarily out of service. Disconnect the power to the control panel before installing the modules. This system contains static sensitive components. Always ground yourself with a proper wrist strap before handling any circuits so that static charges are removed from the body. The housing cabinet should be metallic and suitably grounded.

**NOTICE:** This manual should be left with the owner/user of this equipment.

**GENERAL DESCRIPTION**

The FIK-IM-10 Ten Input Monitor Module is intended for use in an intelligent alarm system. Each monitor module is intended to interface between a control panel and normally open contact devices, such as pull stations. A common SLC input is used for all modules, and the initiating device loops share a common supervisory supply and ground. Otherwise, each monitor operates independently from the others. Each module has its own unique address.

A pair of rotary code switches is used to set the address of the first module from 01 to 150 (01 to 90 on panels that support up to 99 addresses). The remaining modules are automatically assigned to the next nine higher addresses. Provisions are included for disabling a maximum of two unused modules to release the addresses to be used elsewhere. Each module also has panel controlled green LED indicators. The panel can cause the LEDs to blink, latch on, or latch off.

**SHIPPED ON BOARD:**

- (1) Shunt in Class A/B position  
(Shipped in Class B position, remove shunt for Class A)

**INCLUDED:**

- (6) 1 x 4 Terminal Blocks



- (2) 1/4" (32mm) Stand offs

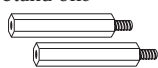

- (4) Machine Screws
- (3) Shunts



- (2) Nuts



- (10) 47k Ohm End of Line Resistors



C0202-00

**COMPATIBILITY REQUIREMENTS**

To ensure proper operation, this module shall be connected to a compatible Fike system control panel.

**COMPONENTS**

The following is a description of the FIK-IM-10 mounting framework:

- One or two FIK-IM-10 modules can be installed in an FIK-BB-2 cabinet.

The FIK-BB-2 cabinet has a built-in chassis that will accommodate one or two FIK-IM-10 modules.

The front FIK-IM-10 module positions of each chassis are offset below the rear

**FIGURE 1: FIK-BB-2 CABINET**

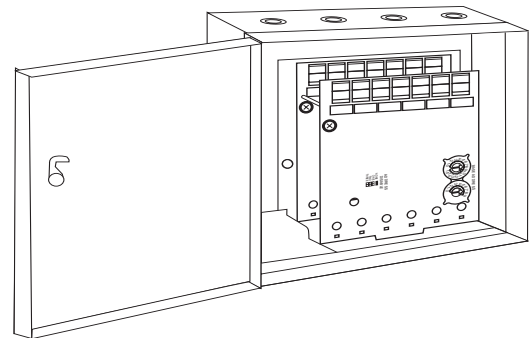

C0234-05

FIK-IM-10 module positions so that all of the status indicators are visible. For cabinet dimensions refer to the FIK-BB-2 instruction manual.

**FIGURE 2: TYPICAL MOUNTING HOLE LOCATIONS**

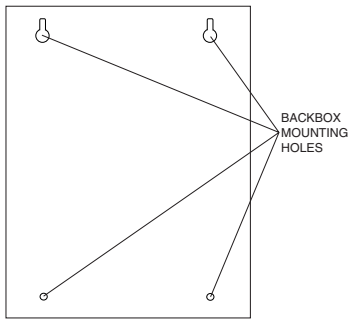

C0235-00

**INSTALLATION STEPS**

**1. Cabinet Mounting**

In a clean, dry area, mount the backbox using the four holes provided in the back surface of the cabinet. (See Figure 2.)

**2. Module Installation**

There are two methods for installing a module in the rear position of a chassis. Method one is for installation of a rear module only, when no module will be installed in front of it. Refer to Figure 3 for instructions. Method two is for installation of a rear module when another module will be installed in the chassis position in front of it. Refer to Figures 4a and 4b for method two. All necessary screws and standoffs are supplied with the modules.

**FIGURE 3. INSTALLATION OF REAR MODULE ONLY, METHOD ONE**

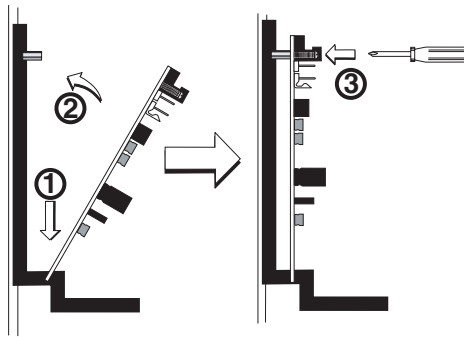

C0237-00

Step 1: Insert the bottom of the FIK-IM-10 module down into a rear slot on the chassis.

Step 2: Carefully swing the upper edge of the board back towards the back of the chassis until it touches the two standoffs.

Step 3: Align two 4-40 screws with the two standoffs and tighten.

Step 4: Address and wire the modules according to the instructions in this manual.

The steps in Figures 4a and 4b describe and illustrate module installation when the rear chassis position and the position in front of it will be filled. Front position installation is possible only if the rear position is filled with a module.

**FIGURE 4A. INSTALLATION OF FIK-IM-10 MODULE IN A REAR CHASSIS POSITION, METHOD TWO**

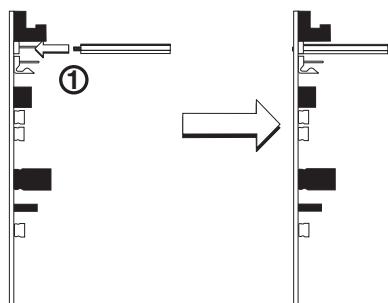

C0225-00

Step 1: Insert the bottom edge of the FIK-IM-10 module down into a rear slot of the chassis.

Step 2: Carefully swing the upper edge of the board towards the back of the chassis until it touches the short standoff attached to the chassis.

Step 3: Align the long standoff with the short stand off and tighten.

**FIGURE 4B. INSTALLATION OF FIK-IM-10 MODULE IN FRONT CHASSIS POSITION**

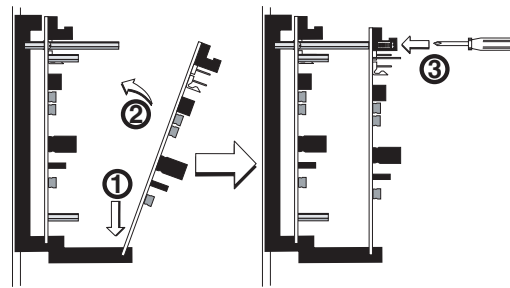

C0226-00

Step 1: Insert the bottom edge of the FIK-IM-10 module down into a front slot of the chassis.

Step 2: Carefully swing the upper edge of the board towards the back of the chassis until it touches the 1/4" (31.75mm) standoffs installed on the rear module.

Step 3: Align two 4-40 screws with the two standoffs and tighten.

Step 4: Address and wire the modules according to the instructions in this manual.

**WIRING**

NOTE: All wiring must conform to applicable local codes, ordinances, and regulations.

1. Install module wiring in accordance with the job drawings and appropriate wiring diagrams.
2. All wiring to the FIK-IM-10 is done via terminal blocks. In order to properly make electrical connections strip approximately 1/4" of insulation from the end of wire, sliding the bare end of the wire under the clamping plate screw.
3. Set the address on the modules per the job drawing. Use the rotary code switches to set the address of the first module between 01 and 90 (or 01 and 150 for panels that support 159 addresses).

In Class B operation, the remaining modules are automatically assigned to the next nine higher addresses. For example, if the base address switch is set to 28, the next nine modules will be addressed to 29, 30, 31, 32, 33, 34, 35, 36, and 37.

**The module is shipped in Class B position, remove shunt for Class A.**

**When operating in Class A,** alternate modules are paired together (+0/+1, +2/+3, +4/+5, +6/+7, +8/+9), resulting in a total of five modules. For example, if the base address switch is set to 28, then 30, 32, 34 and 36 will be automatically assigned to the modules while 29, 31, 33, 35 and 37 are available to be used for other modules on the SLC. For Class A and B operation, DO NOT set the lowest address above 90 (or 150 for panels that support 159 addresses), as the other modules will be assigned to nonexistent addresses.

NOTE: The FIK-IM-10 must have power cycled for shunt changes to take effect.

4. A shunt is provided to disable a maximum of two unused modules in Class B operation and one unused module in Class A operation. Modules are disabled from the highest address and work downward. If two modules are disabled, the lowest eight addresses will be functional, while the highest two will be disabled. For example, in Class B operation, if the shunt for Address Disable is placed on "two" and the base switch is set to 28, the modules will be assigned to 28, 29, 30, 31, 32, 33, 34 and 35 while disabling the highest two positions.
5. A communications loss feature is available on some panels. Upon a communication loss, due to a microprocessor failure at the control panel, the FIK-IM-10 will send a signal to the control panel to activate the notification device circuits upon initiating of an alarm on the FIK-IM-10. A single shunt is used to enable (shunt on) or disable (shunt off) this feature for all modules on the board.

NOTE: All references to power limited represent "Power Limited (Class 2)".

NOTE: Place unused shunts on single pin to store on board for future use.

**WIRING NOTES**

- Power-limited circuits must employ type FPL, FPLR, or FPLP cable as required by Article 760 of the NEC.

**PROGRAMMING**

The modules are programmed as devices in each system according to the programming instructions in the appropriate FACP manual.

**FIGURE 5. TYPICAL INITIATING DEVICE CIRCUIT CONFIGURATION – CLASS B**

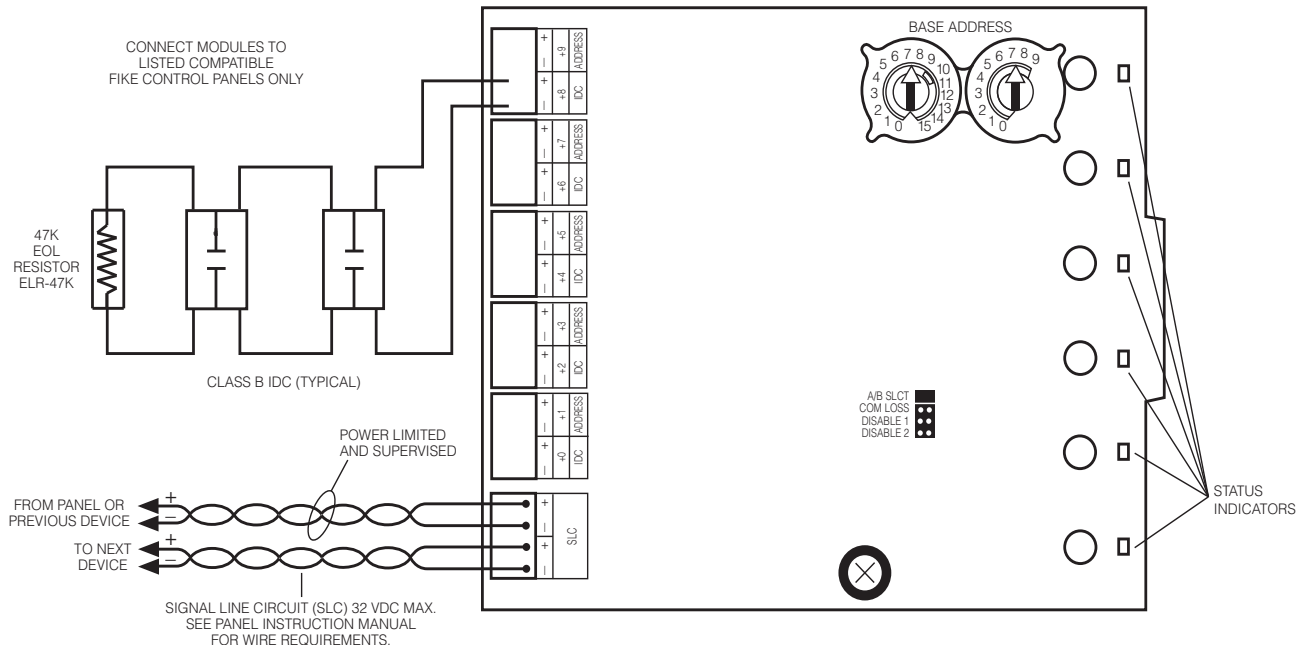

NOTE: Any number of UL listed contact closure devices may be used. DO NOT mix fire alarm initiating and supervisory devices on the same initiating device circuit. Install contact closure devices per manufacturer’s installation instructions.

C0810-04

**FIGURE 6. TYPICAL FAULT TOLERANT INITIATING DEVICE CIRCUIT CONFIGURATION – CLASS A**

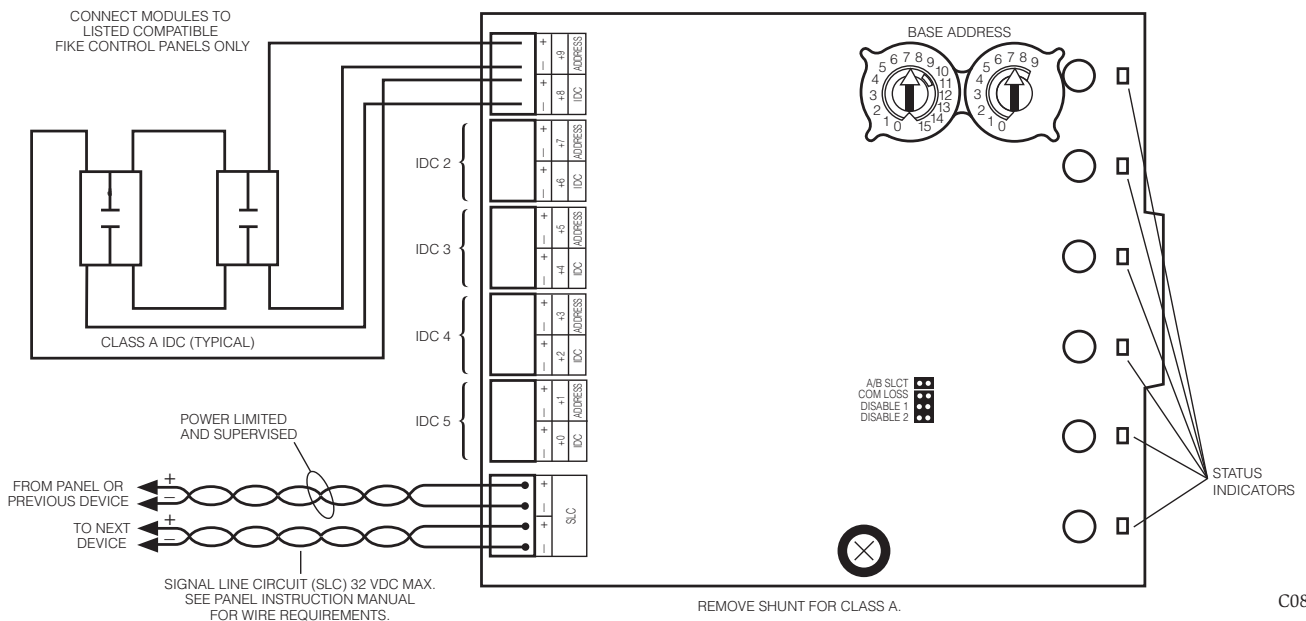

NOTE: Any number of UL listed contact closure devices may be used. DO NOT mix fire alarm initiating and supervisory devices on the same initiating device circuit. Install contact closure devices per manufacturer’s installation instructions.

C0811-04

**FCC STATEMENT**

This device complies with part 15 of the FCC Rules. Operation is subject to the following two conditions: (1) This device may not cause harmful interference, and (2) this device must accept any interference received, including interference that may cause undesired operation.

**NOTE:** This equipment has been tested and found to comply with the limits for a Class B digital device, pursuant to Part 15 of the FCC Rules. These limits are designed to provide reasonable protection against harmful interference in a residential installation. This equipment generates, uses and can radiate radio frequency energy and, if not installed and used in accordance with the instructions, may cause harmful interference to radio communications. However, there is no guarantee that interference will not occur in a particular installation. If this equipment does cause harmful interference to radio or television reception, which can be determined by turning the equipment off and on, the user is encouraged to try to correct the interference by one or more of the following measures:

- Reorient or relocate the receiving antenna.
- Increase the separation between the equipment and receiver.
- Connect the equipment into an outlet on a circuit different from that to which the receiver is connected.
- Consult the dealer or an experienced radio/TV technician for help.

**DEVICE AND SYSTEM SECURITY**

Before installing this product ensure that the tamper seal on the packaging is present and unbroken and the product has not been tampered with since leaving the factory. Do not install this product if there are any indications of tampering. If there are any signs of tampering the product should be returned to the point of purchase.

It is the responsibility of the system owner to ensure that all system components, i.e. devices, panels, wiring etc., are adequately protected to avoid tampering of the system that could result in information disclosure, spoofing, and integrity violation.