

General Description

The Twinflex I/O Module provides an interface between ancillary devices and the zone. It can be configured as an input allowing for reporting from other systems / devices and/or as an output to control external systems. This device may be installed on the same zone as the Multipoint detector/sounder and associated Twinflex devices.

Before Installation

The I/O Module must be installed in compliance with the control panel installation manual. The installation must also meet the requirements of any local authority.

Spacing

The module should be mounted securely and care should be taken to ensure the device is accessible for future maintenance.

Device Installation

All wiring must be installed in compliance with the recommendations laid out by any local authority as well as any special recommendations documented in the control panel installation manual. The cabling used should be of a 2-core 1.5mm² screened, fire resistant type (e.g. FP200 equivalent), and is to be wired in the form of a screened 2-core radial circuit (with no spurs) from the control panel, terminating at the last ("End of Line") device. Note that ALL connections, including inputs, should be made via screened cable.

Fix the back box in a suitable position using at least two of the screw holes provided, remembering to allow enough space for the correct termination of the appropriate fire resistant cable.

Care should be taken when terminating devices to ensure all cables are correctly sleeved and connections are secure. Improper connections will prevent a system from responding properly in the event of a fire.

MAXIMUM CABLE LENGTH TO INPUT 3 METRES.

Connections

In order to carry out high voltage testing and resistance measurements, temporarily connect the incoming and outgoing zone cables to each other using a 3 way connector block. Once all testing has been carried out on the cabling, and 'continuity & integrity' has been proven, the I/O Module may be connected and assembled.

Please remember that all high voltage testing must be carried out before the installation of the I/O Module electronics otherwise the electronics will be damaged.

Remember that the device at the end of the line must have its EOL signal activated using the relevant EOL switch. Do not use a resistor or capacitor (or another manufacturer's End of Line device) as the end of line, as this may prevent correct operation of the zone.

Module Layout

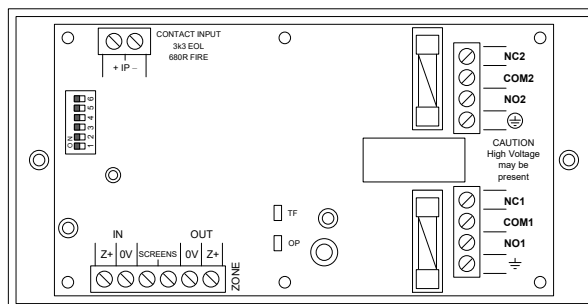

Zone Connections

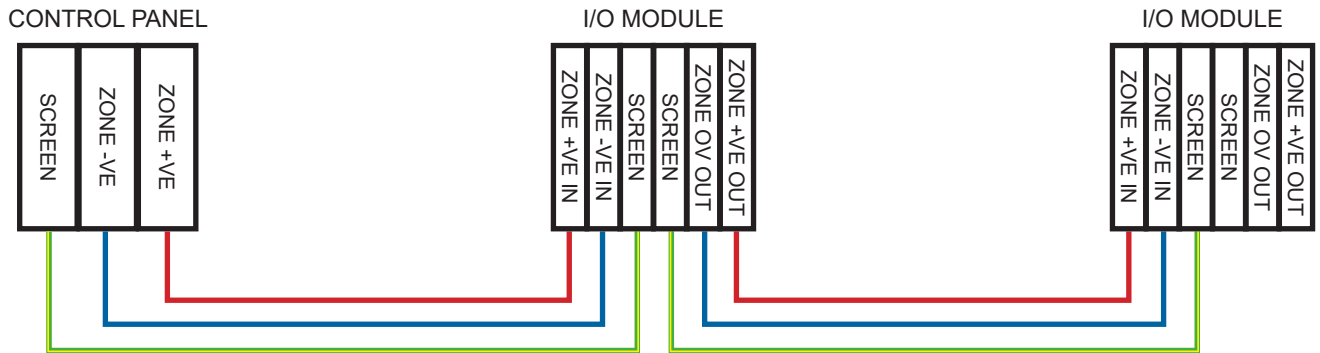

The Twinflex I/O Module can be mixed on the same zone as other types of Twinflex device (eg. Twinflex Multipoint Detectors). The above diagram shows how to make the zone positive, zone negative and screen connections between the control panel and Twinflex I/O Modules. Refer to the instructions of other Twinflex devices for their equivalent wiring/terminal labelling details.

Please note that the "SCREEN" terminals on the I/O Modules should only be connected to the zone cable screen and NOT to the building earth or the back box earth terminal. The cable screen is connected to earth at the panel end only, via the zone "SCRN" terminal (or EARTH terminal on the Twinflex V3 2/4/8 Zone panels). It is important to maintain the screen continuity in order to protect against data corruption from interference.

DIL Switch Settings

The last device on the circuit must have the EOL signal enabled (switch number 1 in the 'ON' position). It may be altered whilst the module is still powered or the system may be powered down completely.

The unit may be configured as an input or an output, or both.

Switches 2-6 are used to set the operation of the on board input and output.

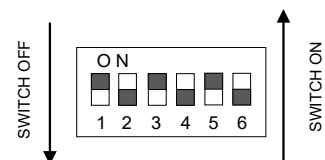

SWITCH NO.	FUNCTION	DESCRIPTION	OFF	ON
1	END OF LINE	Twinflex Zone End of Line Signal	Disabled	Enabled
2	ALARM MODE	Device Alarm to generate when input activated	Detector	Callpoint
3	I/P MODE	Not to be used	Always leave in this position	N/A
4	RESET MODE	Panel Function required to Reset Output	System Reset	Sounders Off
5	OUTPUT MODE		Normal	Disabled if INPUT Active
6	EXTERNAL EOL	Provides EOL resistor to external Device	Disabed	Enabled

Input / Output Wiring

The physical connections are shown below

Input without Fault Monitoring

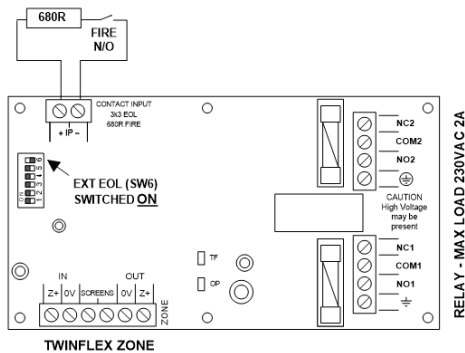

For use as an unmonitored input, connect to input as shown above, **remembering to set the External EOL switch to ON.**

Use a volt free fire contact to make the circuit in order to generate a fire condition.

Input with Fault Monitoring

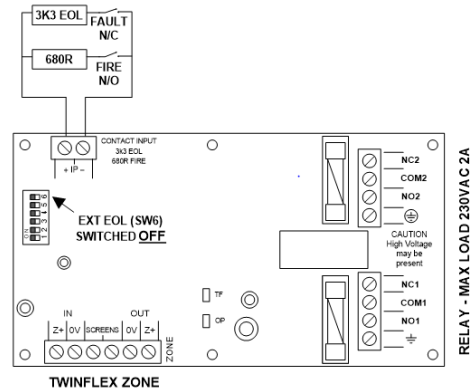

For use as a fault monitored input, connect to input as shown above, **remembering to set the External EOL switch to OFF.**

Use a volt free fire contact to make the circuit in order to generate a fire condition and a volt free fault contact to break the circuit in order to generate a fault condition.

Output Relay without Fault Monitoring

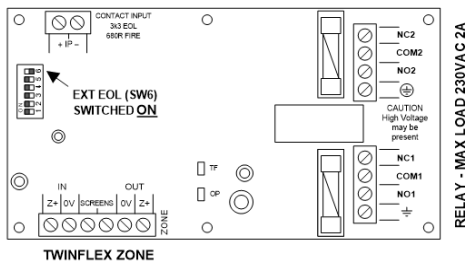

For use as a simple 'change-over' relay output, connect to relay contacts as above, **remembering to set the External EOL switch to ON.**

Output Relay with Fault Monitoring

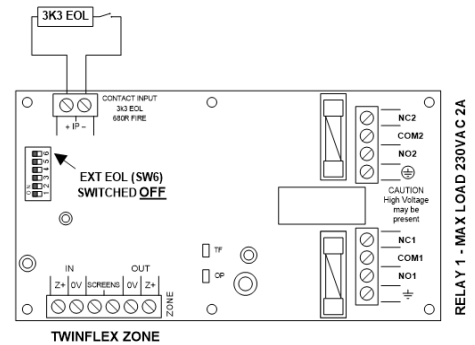

For use as a 'change-over' relay output with fault monitoring, connect to relay contacts and input as shown above, **remembering to set the External EOL switch to OFF**, and to use a volt free fault contact to break the EOL circuit in order to generate a fault condition.

Either mains or low voltage equipment may be connected but **not** both ie. it is not permissible to use one set of contacts for mains and the other for low voltage. If both low voltage and mains switching is required, a second I/O unit must be used such that one unit is dedicated for mains and the other for low voltage.

Any equipment connected to the relay outputs must not respond to a momentary change of the relay contacts when exposed to mechanical shock or impact conditions.

Important notes when connecting mains to the I/O Unit Outputs:

- When connecting mains to the device, a ready accessible disconnect device (eg. a 5A fused spur / switch) must be provided external to the device to enable isolation of the I/O unit.
- The two sets of contact terminals (NC1, NO1, COM1, EARTH and NC2, NO2, COM2, EARTH) may be used to switch Live and Neutral mains voltages (it is recommended that all 230V AC mains voltage connections should switch both Live and Neutral). CAUTION: with double pole/neutral fusing, if one fuse ruptures, the other side of the circuit will still be live.
- The installation of these connections should only be carried out by suitably qualified persons whilst the mains supply is fully isolated.
- The mains cable and low voltage cables (zone and input if applicable) must be kept separate. The low voltage cable must be secured (eg. with cable ties) to avoid bridging to the mains supply if it becomes loose.

Important - Please read before installation:

Twinflex I/O Module Compatibility

The Twinflex I/O Module is compatible with both the Twinflex V3 panel and the Twinflex Pro panel.
The Twinflex I/O Module is not compatible with the Twinflex SRP panel.

Please note the following:

- **When the output facility on the I/O Module is used with a Twinflex V3 panel, the outputs will come on when the sounders are on i.e. if the sound alarms button is pressed. When used with the Twinflex Pro panel, the outputs will only come on in a fire condition.**
- **When the output facility on the I/O Module is used with a V1.17 or earlier Twinflex Pro panel, if the output is activated and a device fault then occurs on the same zone as the output, the output will de-energise. This effect will not occur if the output is on the same zone as the one that is in fire.**
- **If you require the output to remain on constantly in the event of a device fault, V1.18 or later of the Twinflex Pro panel is required.**
- **The Twinflex I/O Module is not compatible with the Twinflex SRP panel.**

Dimensions	Overall.....	146mm x 87mm x 41mm
	Back box.....	146mm x 87mm x 32mm
Operating Temperature	-10°C to +50°C
Voltage Ranges	DC Output from Mains Powered Panel.....	25.5 to 35V DC
	DC Output from Battery Powered Panel.....	20 to 26V DC
Operating Current (Typical)	Quiescent.....	0.207 mA
	End of line ON if applicable..... (in addition to Quiescent)	0.080 mA
	Active.....	22.715 mA
LED Operation	Output Active LED (Red).....	On continuously when output active
	Status - EOL/Input Active LED (Red).....	On continuously when input active
	Flash once every 20 secs for normal Flash once every 5 secs for EOL
Max Cable Length to Input	3 Metres
Contact Rating	DPCO Relay Max load.....	30V DC - 2A
	250V AC 50Hz/60Hz 2A
	Max 3A Surge
Fuses	Fuse 1, Fuse 2.....	3.15A Antisurge 20mm Ceramic
	250V AC (eg. Bussman S505-3.15A)
Loading Units		V3 Panel Pro/Pro² Panel
	Max Loading Units per zone.....	27 SLU 160 DLU
	I/O Unit.....	4 SLU 23 DLU
Flammability	UL94-V2
IP Rating	IP 30 * Not EN54-18 Tested
Part Code	802 0006

NOTE: When used with a Twinflex V3 panel, the outputs will come on when the sounders are on. When used with the Twinflex Pro panel, the outputs will only come on in a fire condition.

Technical Support

Contact your supplier for technical support on this product.

Due to the complexity and inherent importance of a life risk type system training on this equipment is essential, and commissioning should only be carried out by competent persons. Fike cannot guarantee the operation of any equipment unless all documented instructions are complied with, without variation.

Fike's policy is one of continual improvement and the right to change a specification at any time without notice is reserved. Whilst every care has been taken to ensure that the contents of this document are correct at time of publication, Fike shall be under no liability whatsoever in respect of such contents. E&OE

	
Fike Safety Technology Ltd Unit 31, Springvale Ind. Est. Torfaen, NP44 5BD	
DoP-802-0006	
EN54-18: 2005 802-0006	
Intended for use in the fire detection and fire alarm Systems in and around buildings	
Essential characteristics	Performance
Nominal activation conditions/Sensitivity, response delay (response time) and performance under fire conditions	Pass
Operational reliability	Pass
Tolerance to supply voltage	Pass
Durability of operational reliability and response delay, Temperature resistance	Pass
Durability of operational reliability, Vibration resistance	Pass
Durability of operational reliability, Humidity resistance	Pass
Durability of operational reliability, Corrosion resistance	Pass
Durability of operational reliability, Electrical stability	Pass

Notes

Unit 31 Springvale Industrial Estate | Cwmbran NP44 5BD, United Kingdom | +44 (0) 1633 865 558



FIKE SAFETY TECHNOLOGY LTD.

[FIKE.COM](https://www.fike.com)

Unit 31 Springvale Industrial Estate | Cwmbran NP44 5BD, United Kingdom | +44 (0) 1633 865 558



BECAUSE SO MUCH IS AT STAKE™



FIKE SAFETY TECHNOLOGY LTD.

[FIKE.COM](https://www.fike.com)

Unit 31 Springvale Industrial Estate | Cwmbran NP44 5BD, United Kingdom | +44 (0) 1633 865 558



BECAUSE SO MUCH IS AT STAKE™