



QUADNET
FIRE DETECTION SYSTEM

Fire Detection & Alarm System Control Panel V3
(Suitable for Quadnet control panels from V2.00)

Control Panel Engineering and
Commissioning Manual
(TO BE RETAINED BY THE COMMISSIONING ENGINEER)

Fike's policy is one of continual improvement and the right to change a specification at any time without notice is reserved. Whilst every care has been taken to ensure that the contents of this document are correct at time of publication, Fike shall be under no liability whatsoever in respect of such contents.

Due to the complexity and inherent importance of a life risk type system, then training on this equipment is essential, and commissioning should only be carried out by competent persons.

Fike cannot guarantee the operation of any equipment unless all documented instructions are complied with, without variation.

E&OE.

© 2008 Fike Safety Technology Ltd. All rights reserved. Document revised January 2012.

Contents

Introduction.....	5
System Design	5
Equipment Guarantee	5
Anti Static Handling Guidelines	5
Warning	5
EMC.....	5
The Quadnet System.....	6
Advantages of Addressable Systems.....	6
Control Panel	7
Mounting the Control Panel	7
The General Assembly.....	7
Control Panel Disassembly	8
Left Hand Side Door (CIE Door) Removal	9
Physical Dimensions	9
Cabinet Installation	10
Control Panel Assembly	10
Topology and Cabling.....	11
Cable Specification.....	11
Addressable Circuit Wiring	11
Loop Loading.....	12
General System Schematic.....	13
Control Panel Main PCB.....	14
Control Panel Terminals	16
Network.....	22
Network Topology and Cabling	22
Network Cable Specification.....	22
Network Connection Schematic	23
Network Terminals.....	23
General Operation of Control Panel	25
Control Panel Front	25
LED Indication	26
Fire Alarm Controls.....	28
System Controls	28
Access Levels and Codes	29
Access Level 1 (Normal)	29
Access Level 2A (User).....	29
Access Level 2B (Supervisor)	30
Access Level 3 (Engineer).....	34
Printer	40
Alarm Confirmation	41
Alarm Confirmation Delay	42
Selecting the Devices.....	42
Commissioning.....	43
Installation 1st Stage	43
Installation 2nd Stage.....	43
Initialisation	43
Commissioning	44
Configuration Example	45
End User Training.....	45

Good Practice	46
Number of Devices	46
Label the Loop Ends	46
Note the Loop Readings	46
Configuration Printout and Drawings	47
Initialisation	48
Normal Readings	48
Initialisation Process	48
Initialisation Faults	49
Earth Faults.....	51
General Fault Finding	53
Common Faults	53
Intermittent and Recurring Faults	54
Summary of Messages	56
Advanced Connections	59
Monitored Relays	59
Technical Data	60
Control Panel	60
Power Supply Unit	61
System Version Compatibility	61
OSP Version Compatibility	61
Resistor Colour Codes.....	62
Battery Calculations	63
Installation Checklist	64
Commissioning Checklist.....	65
Loop Continuity and Insulation Test Results	66
Network Continuity and Insulation Test Results	67
Fire Alarm System Notice	68
Device Details	70
Your Notes	71
Important Points	74 – Back Page

Introduction

This Manual is intended as a guide to the engineering and commissioning principles of the Quadnet Addressable Intelligent Fire Alarm and Detection system, and covers the system hardware information only.

Due to the complexity and inherent importance of a system covering a 'Life Protection Risk', training on this equipment is essential, and commissioning should only be carried out by competent and approved persons. For further details of the availability of commissioning services contact your supplier.

System Design



This document does not cover Fire Alarm system design, and a basic understanding is assumed.

A knowledge of BS5839: Pt 1: 2002 +A2: 2008 : Fire Detection and Alarm Systems for Buildings is essential.

It is strongly recommended that a suitably qualified and competent person is consulted in connection with the Fire Alarm System design and that the entire system is commissioned in accordance with the current national standards and specifications.

Equipment Guarantee



The equipment carries no warranty unless the system is installed, commissioned and serviced in accordance with this manual and the relevant standards by a suitably qualified and competent person or organisation

Anti Static Handling Guidelines



Immediately prior to handling any PCBs or other static sensitive devices, it is essential to ensure that a personal **connection to earth is made with an anti-static wrist-strap** or similar apparatus.

Always handle PCBs by their sides and avoid touching any components. PCBs should also be stored in a clean dry place, which is free from vibration, dust and excessive heat, and protected from mechanical damage.

Warning



Do not attempt to install this equipment until you have fully read and understood this manual.

Failure to do so may result in damage to the equipment and could invalidate the warranty.

Technical support will not be available if the instruction manual has not been read and understood. Please have this instruction manual available whenever you call for technical support.

For further technical support please contact your distributor. Do not call the Fike Safety Technology support department unless your distributor has first given their advice and attempted to rectify the issue.

EMC



This equipment when installed is subject to the EMC directive 2004/108/EC. It is also subject to UK Statutory Instrument 2006 No. 3418.

To maintain EMC compliance this system must be installed as defined within this manual. Any deviation from this renders the installer liable for any EMC problems that may occur either to the equipment or to any other equipment affected by the installation.

The Quadnet System

The Quadnet system is an addressable intelligent detector system, with many advantages over traditional addressable analogue detector systems. In order to understand the benefits, let us look more closely at the terms **Fire Detector** and **Fire Sensor**. These terms are often used interchangeably but actually have quite different meanings. A fire detector is the device (component as defined in EN54) which automatically detects a fire. In the majority of addressable fire detection systems, the fire devices are in fact fire sensors which only transfer data relating to smoke and heat levels to the control panel, and the fire decision is made by the panel.

Nearly all current addressable systems are **Addressable Analogue Detector Systems** where the control panel continually scans the fire sensors, processes the returned data, and makes decisions about fires and faults.

The Quadnet system is defined as an **Addressable Intelligent Detector System** or an **Addressable Fire Detection and Alarm System with Independent Distributed Intelligence**. Distributed intelligence signifies that the signal processing is spread throughout the system, in order that the decisions about fires and faults are taken within the detector itself. The detector is capable of being remotely programmed for different modes of detection.

Thus the Quadnet system is an analogue addressable system, but with the processing power distributed across the entire system. This dramatically reduces the complexity of the control panel and the data traffic, and improves the efficiency of the system.

The system addressing is carried automatically upon initialisation from the control panel, and does not need to be programmed manually at each device.

Advantages of Addressable Systems

The nature of a microprocessor control system with individually identified devices means that the precise location of fires and faults may be indicated, more complex actions may be implemented, system flexibility is improved and installation and cabling costs are reduced.

In the Quadnet system, very efficient communications mean that very low quiescent power consumption maximises the standby capacity, high power transfer capabilities allow more sounders to be connected to the loop, and a very fast response to events is achieved as the control panel does not have to poll every device for status data.

IMPORTANT NOTE:

The Quadnet Panel is a 2 box solution comprising a Control Panel (as per this manual) and a matching Power Supply Unit. This manual describes the Quadnet Control Panel. Please refer to the Quadnet Power Supply Unit Installation Instructions for details of how to install the Power Supply Unit and connect it to the Quadnet Control Panel.

Control Panel

Mounting the Control Panel

First identify the proposed location for the control panel. Ensure that the control panel will be easily accessible, and that account is taken of any subsequent work that may affect access. It should be located at the most likely point of access for the fire services.

The control panel should be mounted on a flat, vertical wall at a height where the indicators may be seen without difficulty.

Like all electronic equipment, the control panel may be affected by extreme environmental conditions. The position selected for its installation should therefore be clean and dry, not subjected to high levels of vibration or shock and at least 2 metres away from any pager or radio transmitting equipment. Ambient temperatures should be within the range given within the Technical Data section, i.e. not directly over a radiator or heater or in direct sunlight.

In common with all microprocessor-controlled panels, the control panel may operate erratically or may be damaged if subjected to lightning induced transients. Proper earth/ground connections will greatly reduce susceptibility to this problem.

The General Assembly

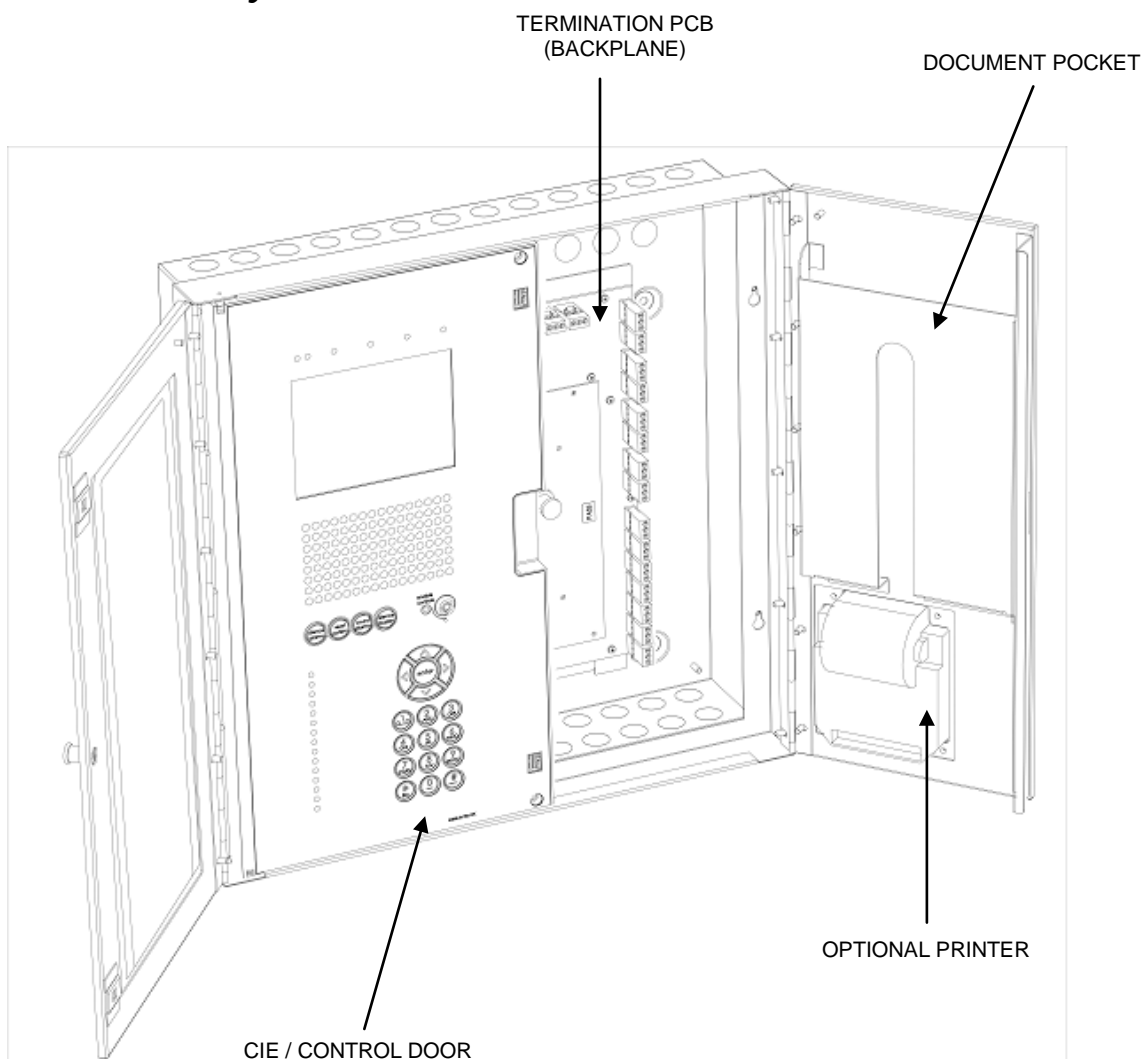

Control Panel Disassembly

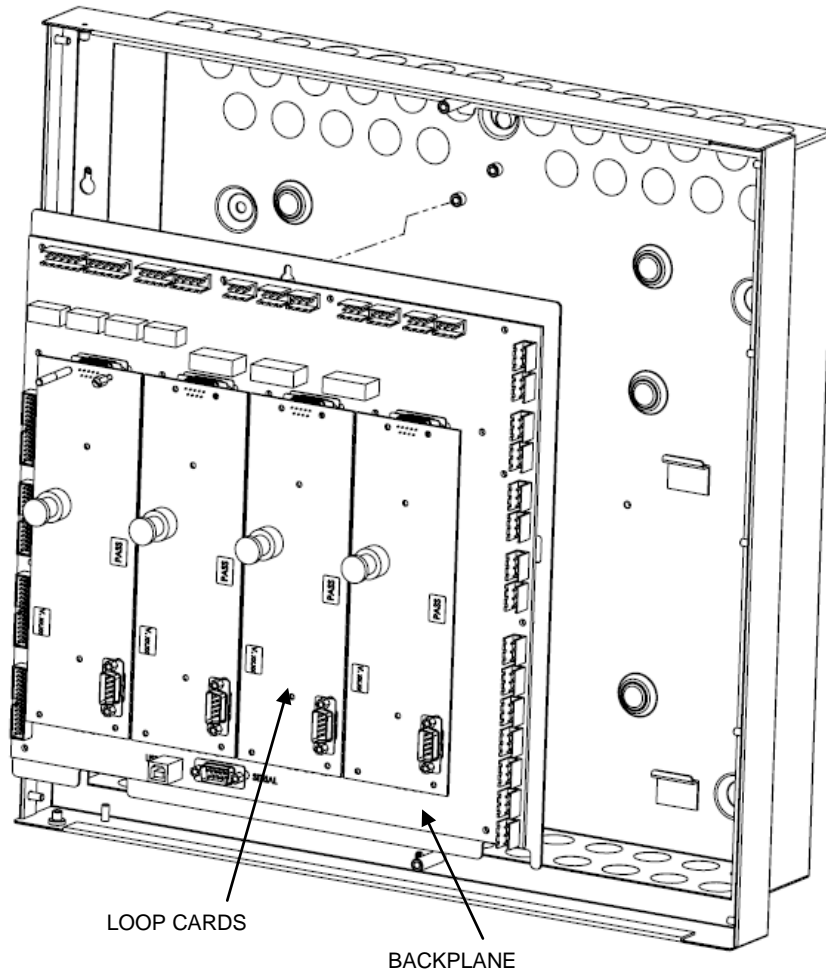

The panel is normally supplied disassembled to make first fix easier. If the panel is already assembled it must be disassembled in order to fix the backbox to the wall.

The front left hand door (CIE door) which houses the panel controls must be opened and the ribbon cables unplugged from the main backplane.

Remove the collar / flange assembly complete with doors. Loosen the 4 screws in the keyhole slots (2 per side). Remove the retaining screws (2) one at the top and one at the bottom. Lift off the collar / flange assembly complete with doors and set aside.

The backplane is mounted on a chassis which is fixed into the box by 1 screw at the top. There are two metal retainers at the bottom.

The screw must be loosened then the chassis plate can be lifted up and out of the box.

Left Hand Side Door (CIE Door) Removal (if required)

If the panel is assembled and it is necessary to remove the left hand door that houses the CIE in order to replace the CIE, the door must be opened to its full extent and the ribbon cables unplugged from the main backplane.

Then it must be gently taken beyond its fully opened extent. This will cause the hinge pins to pop out of the door. The door can then be completely removed.

Note: a minimum gap of 320mm must be left between the back box and any wall or projection to allow the door to be gently taken beyond its full extent and removed

Physical Dimensions

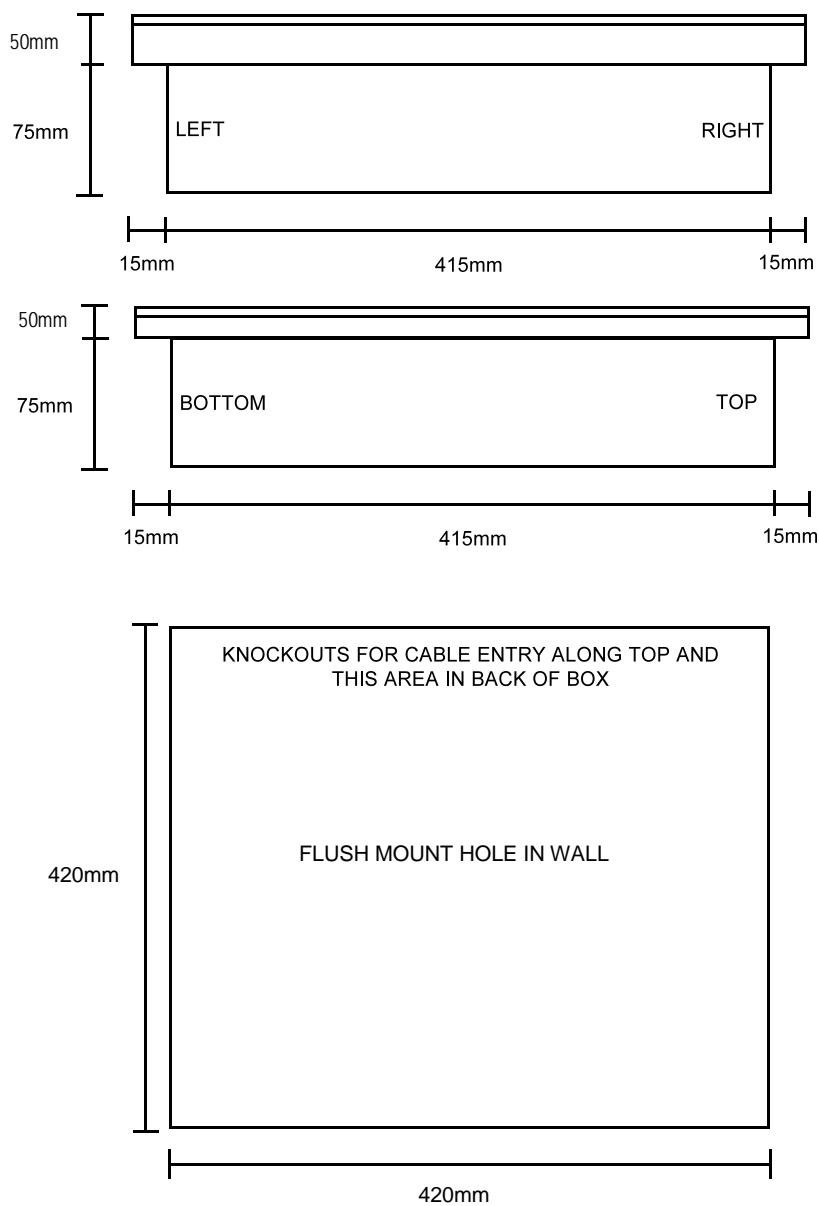

Cabinet Installation

This backbox is compatible with the Quadnet range of Fire Alarm Control Equipment and is common to the range of control panels, repeater panels and power supply units.

Surface Mounting

At least four of the five mounting holes should be used to secure the cabinet to a solid wall using suitable screws of at least 50mm in length. Ensure that a minimum gap of 50mm is left between the sides of the backbox and any wall or projection (such as another box). On the left hand side, a larger gap of 320mm must be left to allow future removal of the CIE door in situ.

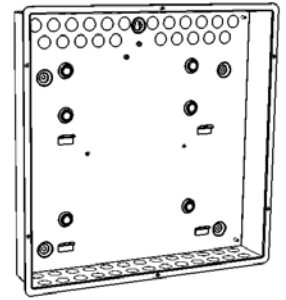

Cable Entry

The cable entry locations available will depend on the type of unit that is intended, and it is important to note which cable entry areas are suitable for each derivative.

Quadnet Control Panel

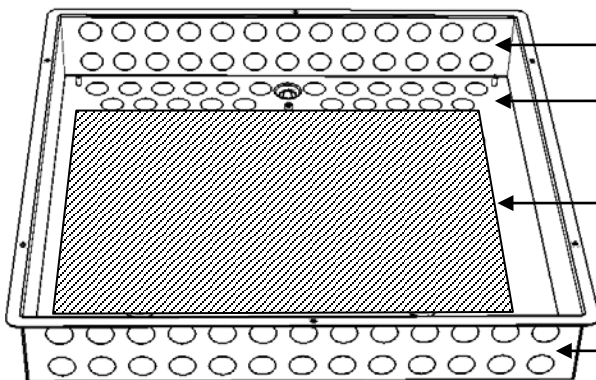

- ← The two rows of knockouts at the top are suitable.
- ← The two rows of knockouts in the rear at the top are suitable.
- ← The main rear face must be kept clear for mounting the electronics.
- ← The two rows of knockouts at the bottom are suitable.

Technical Data

Dimensions:	Width x Height (excluding flange)	415mm x 415mm
	Width x Height (including flange)	445mm x 445mm
	Depth	75mm
Flush Mount Hole Size	Backbox only	420mm x 420mm

Control Panel Assembly

This is the reverse of the disassembly process above.

To refit the front left hand door, which houses the panel controls, the right hand door must be opened. The left hand door should then be lined up with the hinge pins and then gently closed. Closing the door will cause the hinge pins to pop back into the door.

The ribbon cables are labelled Ribbon A, Ribbon B, Ribbon C and Ribbon D on both the front door PCB and the backplane. These cables must be reconnected as follows: Ribbon A on the front panel PCB to Ribbon A on the backplane, Ribbon B on the front panel PCB to Ribbon B on the backplane and so on.

Topology & Cabling

All system wiring should be installed to comply with BS 5839: Pt 1: 2002: Amendment 2: 2008 and BS 7671 (wiring regulations) and any other standards relevant to the area or type of installation. A cable complying with the BS 5839: Pt 1: 2002 Category 1 (cables required to operate for prolonged periods during fire conditions) is required. This must be a 2-core 1.5mm² screened fire resistant cable (ie. MICC, FP200, Firetuff, Firecell, Lifeline or equivalent). Ventcroft No-Burn multicore cable was utilised during the LPCB approval testing.

Cable Specification

Max Capacitance Core to Screen.....	180pF / m
Max Capacitance Core to Core	100pF / m
Max Inductance.....	1.0mH / km
Max Resistance Two Core Screened 1.5mm ²	12.1Ω / km
Fire Proof	BS5839: Pt1: 2002 Category 1
Example	Datwyler 8700

Addressable Circuit Wiring

The addressable circuit must be installed as a loop with a maximum length of up to 2 km. Addressable spur circuits are NOT permitted with this system.

In order to protect against possible data corruption it is important ensure the following points are adhered to:

1. The addressable circuit cable **screen must be connected to the loop SCRN terminal at the control panel**. Both ends must be connected using the terminals provided.
2. The addressable circuit cable screen must not be connected to earth/ground at any point other than the control panel (at the SCRN terminal provided, not at any earthing point). **Do not connect the screen to a device back box.**
3. The addressable circuit cable **screen continuity must be maintained** at every point of the loop, using the terminals provided or a suitable connection block.
4. Do not use a 4-core cable as a loop **feed & return** due to the possibility of data corruption. It is essential that two 2-core cables are used if this is required.
5. Excess cable lengths **must not be coiled** as coiling will increase the inductance and cause communication problems.

Loop Loading

In order to allow a method of calculating the maximum loop loading that the system will support, each device has a rating assigned in Device Loading Units (DLUs). This relates to the load presented in alarm. A maximum of 450 DLUs are permissible on each loop (subject also to a maximum of 200 addressable devices, whichever limit is reached first).

The DLUs of the current models of devices as at October 2011 are as follows:

PRODUCT DESCRIPTION			DLU RATING			
Type	Product Code	Subtype	SP0- Off	Low	Medium	High
MP	203 0003	Multipoint Mk3	1	-	-	-
	205 0003	ASD Mk3	1	-	-	-
MPS	203 0001	Multipoint with Sounder Mk3	1	1.5	4.5	6
	205 0001	ASD with Sounder Mk3	1	1.5	4.5	6
	205 0012	ASD with Sounder/Strobe Mk3	4.5	5	8	10
MCP	403 0006	Manual Call Point Mk3	3	-	-	-
	403 0007					
SOUNDER	313 0001	Soundpoint Mk3	1.5	2	4	5.5
	313 0002					
	323 0001	Hipoint Mk3	1.5	2	4	5.5
	303 0013	Bell Mk2	2	22	22	22
	303 0012	Flashpoint	1.5	4.5	6.5	8
	303 0022					
	326 0021	Sounder/Strobe	9	9.5	11.5	13
326 0023						
326 0001	Sounder	1.5	2	4	5.5	
326 0003						
326 0015	Strobe	9	-	-	-	
I/O	803 0006	Loop I/O Module Mk2	10.5	-	-	-
CZM	803 0010	Conventional Zone Module (Loop Powered)	23.5	-	-	-
	803 0010	Conventional Zone Module (Ext PSU)	3.5	-	-	-
ANCILLARY	803 0003	Multipoint I/O Module (in Relay Base)	3	-	-	-
	803 0005					
	600 0092	Remote Indicator	0.5	-	-	-

The Quadnet OSP programming software v2.02 or later (v2.04 or later required for the latest devices) automatically keeps control of the quantities and DLU ratings of devices on the loop and will warn the engineer if the limit is reached. It will not allow a system to be programmed to exceed the maximum DLU rating. It can detect the type of the device and, in the case of devices manufactured from March 2010, the subtype from the above list as well. For devices manufactured prior to this date, the Quadnet OSP will attempt to detect the subtype and use the appropriate DLUs. The engineer can override the automatically detected subtype if required ie. if the OSP cannot correctly identify an older device, the engineer can tell the system that the device is a different subtype to the one OSP has selected (eg. Soundpoint instead of Flashpoint) within the same main type.

- Note:**
- 1) An Excel spreadsheet (document no. 26-1049) is also available to automatically work out both standby battery calculations and loop loading calculations based on the quantities entered. This includes ratings for legacy devices as well as the above current models.
 - 2) Whilst the system will operate a maximum of 800 devices per control panel, for compliance with EN54-2, it is recommended that a limit of a maximum of 512 detection devices is adhered to. This includes detectors and manual call points, but does not affect the number of sounders or other alarm devices on the system.

General System Schematic

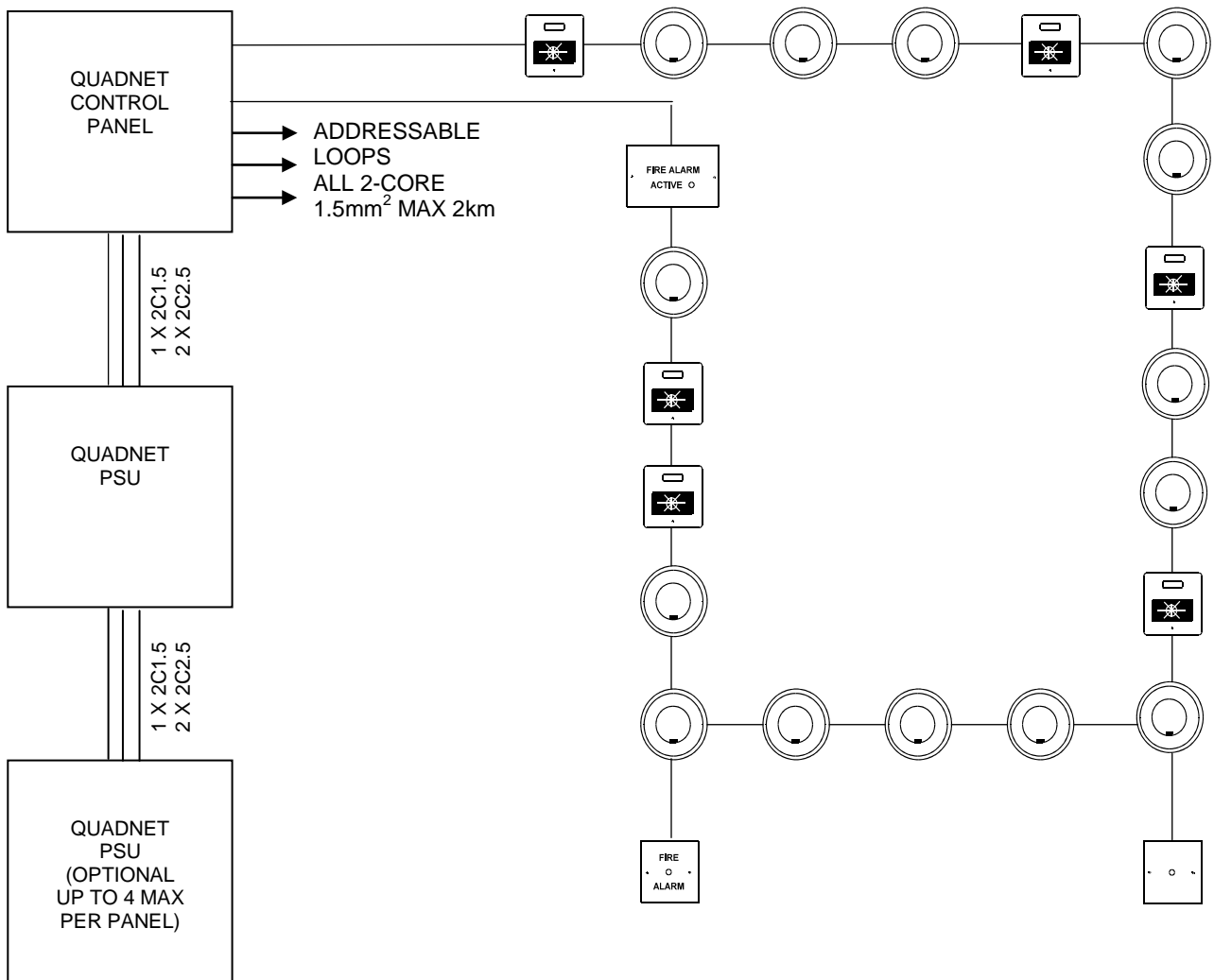

 Sita Multipoint

 Sita MP I/O

 Sita MCP

 Remote Indicator

 Sita Loop I/O Module

Control Panel Main PCB Located on the inside of the front left hand inner door.

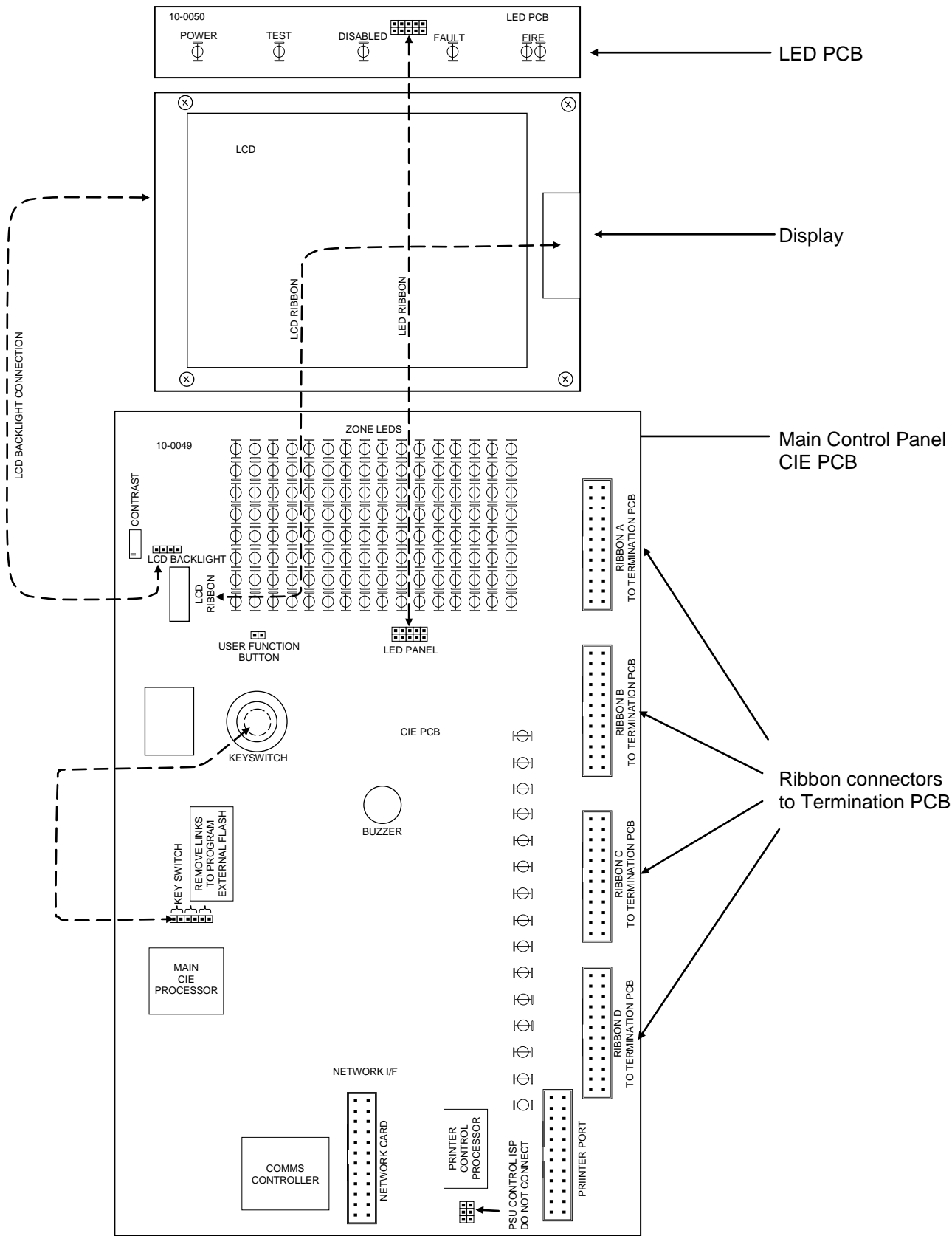

Control Panel Firmware Upgrade Link Pins

The control panel firmware may be upgraded on site if required using the External Flash Upgrade software.

The two link pins located to the right of the key switch connector **MUST** be left in position for correct field operation and only removed when performing the flash upgrade.

Before undertaking any upgrades, it is important to make sure that the proposed new software is compatible with the system hardware version and with the other panels and components in the system.

Note that firmware upgrades are only permitted to be carried out by Fike engineers or trained installation engineers operating under specific instructions from Fike Technical Support.

LCD Contrast

The LCD contrast may be adjusted by rotating the screw on the variable resistor located in the upper left hand corner of the main PCB. This may require many (10 to 20) rotations if the contrast is particularly out of adjustment.

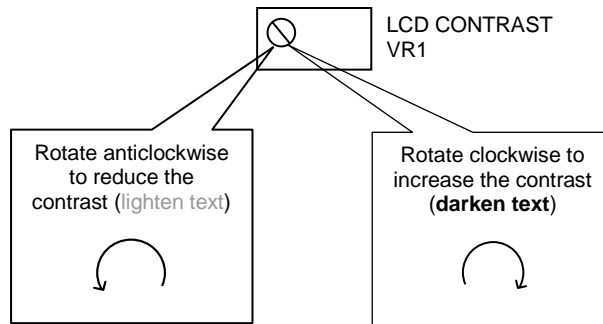

Control Panel Terminals

The Termination and PSU PCB (also known as the backplane) is located at the rear of the main control panel back box.

The Loop cards may be plugged into the loop card slots on the backplane. **To avoid damage, ensure that the panel is powered down whilst connecting and removing the loop cards.** When connecting, do not press down on the loop card other than where indicated. Similarly, when removing, do not pull the centre of the card but pull from both ends at the same time so that the PCB does not get flexed.

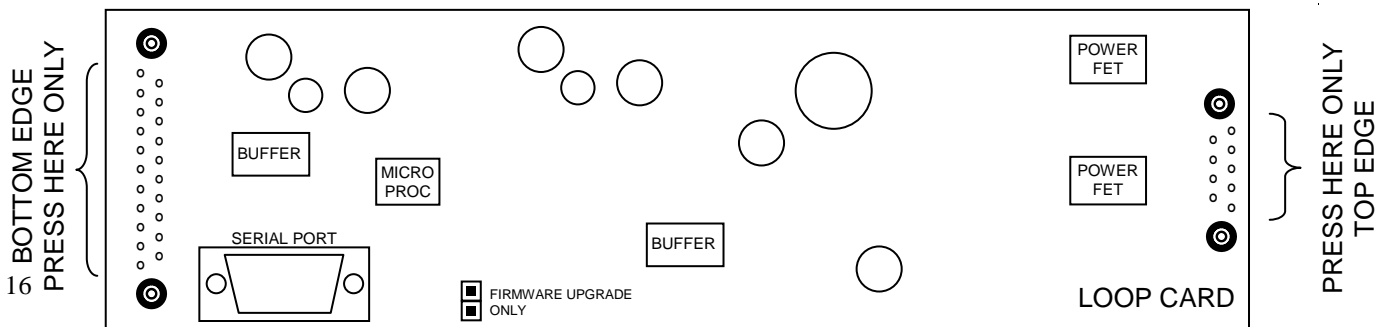
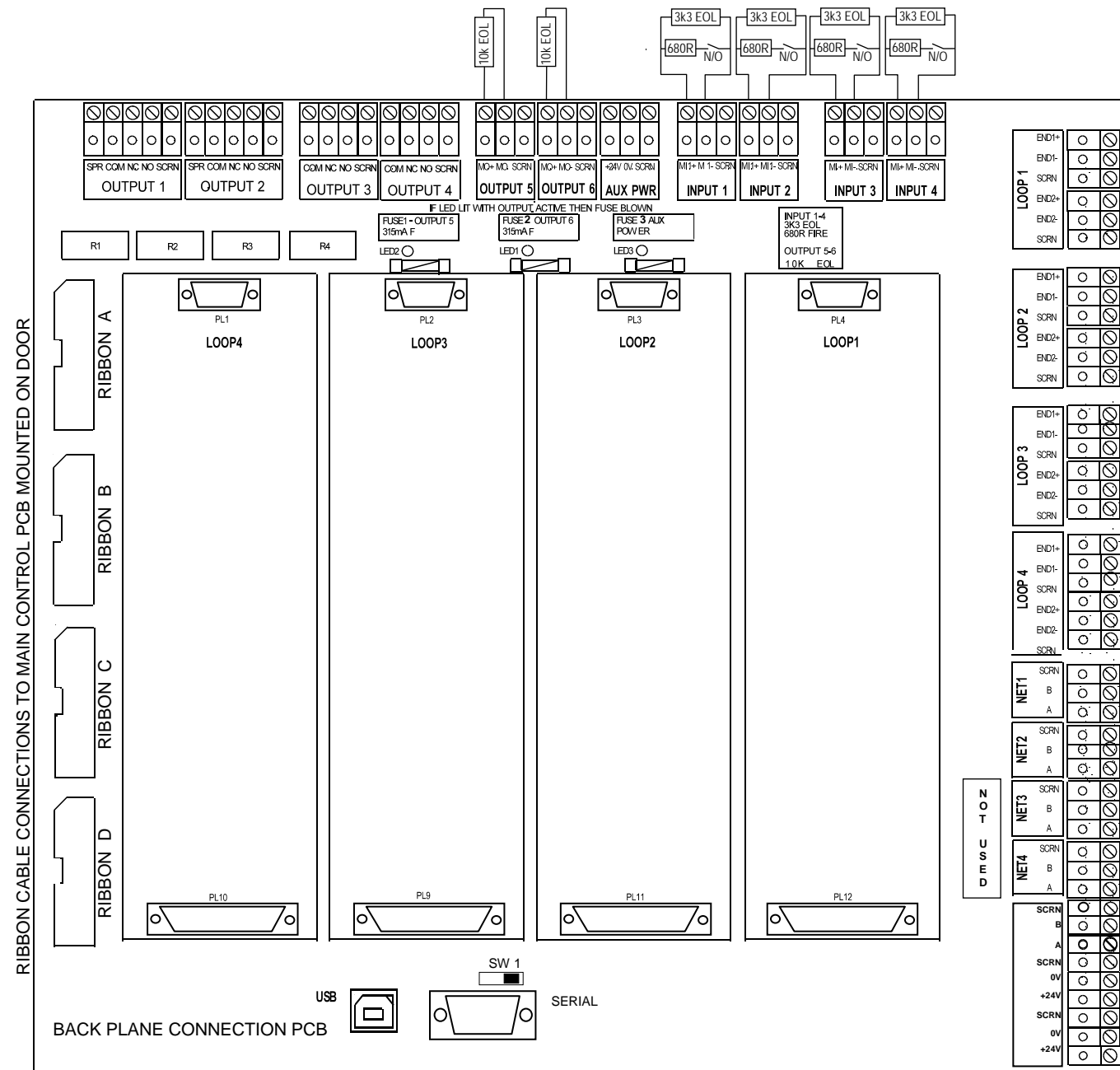

Loop Card Serial Port

The serial port may be used for connection to a computer running the Diagnostic software in order to interrogate the loop communications; it is also used to upgrade the firmware of the loop card.

Loop Card Firmware Upgrade Link Pins

The loop card firmware may be upgraded on site using the external flash utility. The link pin should be left connected for correct field operation and removed for firmware upgrade.

Note that firmware upgrades are only permitted to be carried out by Fike engineers or trained installation engineers operating under specific instructions from Fike Technical Support.

Outputs 1 and 2: SPR, COM, NC, NO, SCRIN

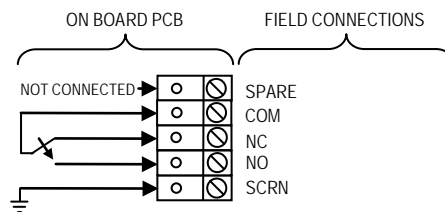

Outputs 1 and 2 are derived from single pole change over 'volt-free' relay contacts which are not fault monitored. The relay contacts are rated at 30V DC / 1A max. All inductive loads should be diode protected to prevent back EMF. However, if this is not done, the load should be limited to 200mA to reduce the likelihood of back EMF causing damage to the relay contacts.

The default setting for Output 1 causes the relay to operate as a **Common Fire** output where the relay is energised in the fire condition. The default setting for output 2 causes the relay to operate as a **Common Fault** output where the relay is de-energised in the fault condition. Various other modes may also be set using the Quadnet OSP programming software. However, to meet the requirements of EN54-2, Output 1 must be left as a fire output (**Common Fire** or **Zonal Fire**) and Output 2 must be left as **Common Fault**. On later versions of the panel hardware, Output 2 is optimised for Common Fault use and has an additional safety feature (which cannot be disabled) to turn off the output in the unlikely event of the operating software stopping, even if not specifically configured as **Common Fault**.

Terminal	Description
SPR	Spare terminal for general use. Not connected internally.
COM	Common contact
NC	Normally closed contact
NO	Normally open contact
SCRIN	Field cable screen connection

Outputs 3 and 4: COM, NC, NO, SCRIN

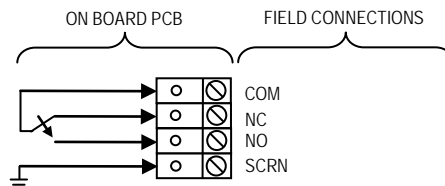

Outputs 3 and 4 are single pole change over 'volt-free' relay contacts which are not fault monitored. The relay contacts are rated at 30V DC / 1A max. All inductive loads should be diode protected to prevent back EMF. However, if this is not done, the load should be limited to 200mA to reduce the likelihood of back EMF causing damage to the relay contacts.

The default setting for Output 3 and Output 4 is "not configured". Various modes may be set using the Quadnet OSP programming software.

Terminal	Description
COM	Common contact
NC	Normally closed contact
NO	Normally open contact
SCRN	Field cable screen connection

Outputs 5 and 6: MO+, MO-, SCRN

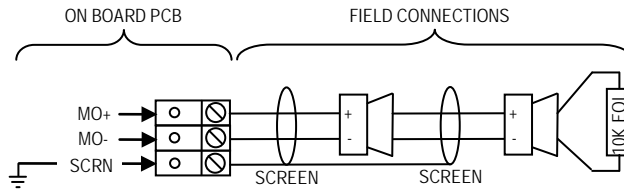

Outputs 5 and 6 are monitored circuits which may be configured to monitor for open and short circuit faults with a 10K EOL resistor, and to be activated with a stage 3 alarm.

The default setting for outputs 5 and 6 causes the circuits to operate as **Common Fire Sounder Circuits**, where the outputs turn on in the alarm condition. Various other states may also be set using the Quadnet OSP programming software.

The maximum output current for each output is **200mA**. These outputs are protected by the **315mA T fuses** labelled FUSE 1 and FUSE 2.

Terminal	Description
MO+	Monitored Output positive connection
MO-	Monitored Output 0V connection
SCRN	Field cable screen connection

Auxiliary Power: +24V, 0V, SCRN

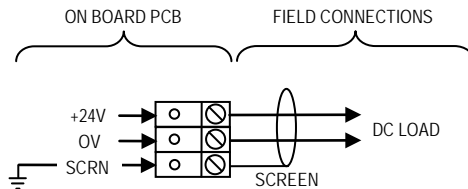

An auxiliary nominal 24V DC power supply is available to power ancillary devices requiring up to 30V DC. The maximum output current is **200mA**. The Auxiliary Power is protected by a **F315mA fuse** labelled FUSE 3. It is suggested that additional Power Supply Units be installed to provide power for additional loads.

Note: The auxiliary nominal 24V power supply output will be approximately 30 – 31V DC when the panel is running from a mains supply and between 20 and 27V DC when running from the batteries in a mains failure condition. Please ensure that the equipment to be powered from this output is capable of operating from between 19V and 32V DC.

Terminal	Description
+24V	Aux power positive connection
0V	Aux Power 0V connection
SCRN	Field cable screen connection

Inputs 1- 4: MI+, MI-, SCRN

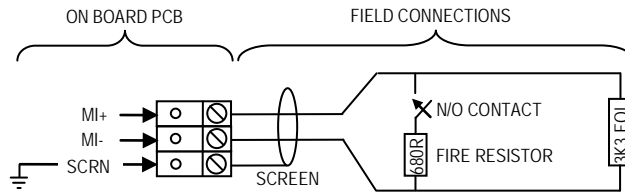

Inputs 1-4 may be configured to monitor for open and short circuit faults using a 3k3 EOL resistor, and to activate an alarm link using a 680R 'firing' resistor.

Terminal	Description
MI+	Monitored Input positive connection
MI-	Monitored Input 0V connection
SCRN	Field cable screen connection

Fuses 1-3: FUSE 1, FUSE 2, FUSE 3

The fuses are located towards the top of the back plane PCB.

Blown fuses are easy to spot using the LED adjacent to each fuse. This will switch on if the output is switched on (even in the passive state) and the fuse is blown.

Label	Description	Fuse
FUSE 1	Output 5	F315 mA
FUSE 2	Output 6	F315 mA
FUSE 3	Auxiliary Power	F315 mA

Addressable Circuit Loops 1- 4: END1+, END 1-, SCRN, END2+, END2-, SCRN

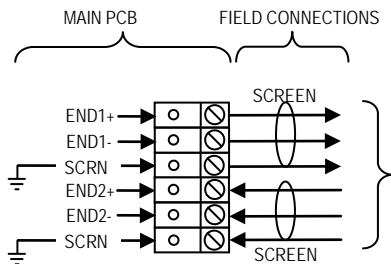

Each loop 1-4 addressable circuits must be connected to its appropriate End 1 and End 2 terminals.

Communications normally run from Loop End 1 but, in the event of a continuity fault, both ends of the circuit will operate.

It is important that the cable screen is only connected at the control panel (using the SCRN terminal provided, not at any earthing point), and that the screen continuity is maintained at all times. 4-core cable must not be used as a loop 'feed & return' due to the possibility of data corruption.

Terminal	Description
LOOP END1+	Circuit End 1 positive connection: +VE OUT
LOOP END 1 -	Circuit End 1 0V connection : 0V OUT
SCRN	Field cable screen connection: SCRN OUT
LOOP END2+	Circuit End 2 positive connection: +VE IN
LOOP END 2 -	Circuit End 2 0V connection : 0V IN
SCRN	Field cable screen connection: SCRN IN

USB Port: USB

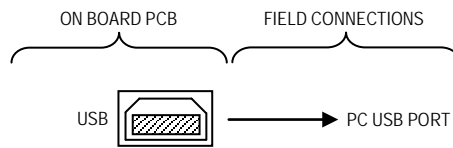

The Quadnet control panel may be programmed using the Quadnet OSP programming software using a USB lead to link to a computer. This allows the site specific data to be customised as required.

NOTE: It is imperative that the correct version of OSP is used to match your version of Quadnet control panel. The use of an incompatible version may result in incorrect operation of the control panel. In particular, do not use a V2.xx series OSP with a V3.xx series control panel and do not use a V3.xx series OSP with a V2.xx series control panel.

Serial Port: SERIAL

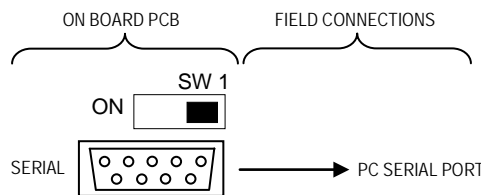

The Quadnet control panel firmware (control panel operating software stored in external flash memory on the control panel CIE PCB) may be updated using the Quadnet Firmware programming software using a serial lead to link to a computer. This allows the control panel software version to be updated on site as required. To enable the flash upgrade option switch 1 must be in the ON position. During normal operation switch 1 must be set to OFF.

It is important to ensure that the new version is compatible with your hardware version and with other software used in the system such as loop cards, PSU and repeaters etc. If not, then all items would need to be updated.

Note that firmware upgrades are only permitted to be carried out by Fike engineers or trained installation engineers operating under specific instructions from Fike Technical Support.

Network Ports 1- 2: B, A, SCR N

The network ports allow multiple panels to be connected together, up to a maximum of 4 panels (including both control panels and repeater panels). The 2 network ports (NET1-2) may be connected in any sequence between panels. Note Network ports 3 + 4 are not currently used.

Note that although the terminals for the network ports are always fitted on the backplane, they may only be used if the optional Quadnet Network Card has been fitted onto the control panel main PCB (CIE).

Network Port 1

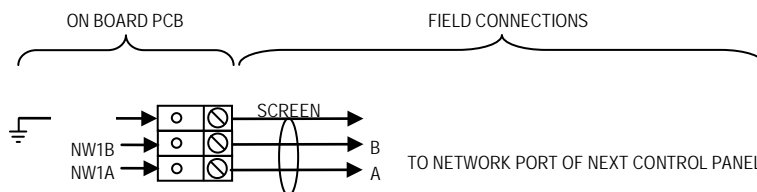

Terminal	Description
SCR N	Field cable screen connection (Connect only at 1 end)
NW1B	Data B connection for Port 1
NW1A	Data A connection for Port 1

Network Port 2

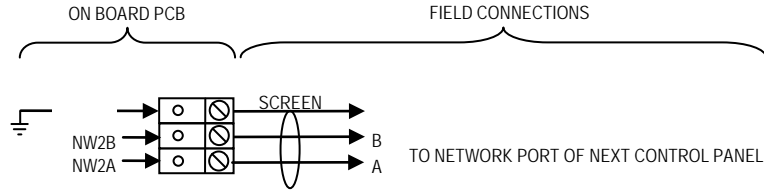

Terminal	Description
SCRN	Field cable screen connection (Connect only at 1 end)
NW2B	Data B connection for Port 2
NW2A	Data A connection for Port 2

PSU: SCRN, B, A, SCRN, 0V, +24V, SCRN, 0V, +24V,

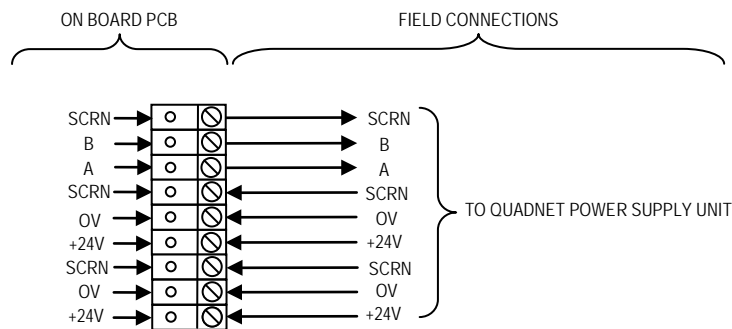

The PSU connections connect the control panel to the Power Supply Unit.

A 2-core 1.5mm² cable should be used for the data connections (A and B), up to a maximum of 9.5m in length.

Two 2-core 1.5mm² cables may be used for the 2 x +24V and 0V power connections, up to a maximum of 6.3m in length. The cables screens should be connected at each end using the terminals provided

If a greater distance is required between the main control panel and the PSU then two 2-core 2.5mm² cables should be used for the +24V and 0V power connections, up to a maximum of 9.5m in length. The cable screens should be connected at each end using the terminals provided

Terminal	Description
A	Serial Data connection
B	Serial Clock connection
+24v	Power Supply +24V Input connection
0V	Power Supply 0V Input connection
SCRN	Cable Screen

Network

Network Topology and Cabling

In order to use the networking features of the Quadnet system, each control panel must have the optional Quadnet network card fitted onto the control panel main PCB (CIE). Quadnet repeater panels automatically include this network card as standard since repeaters can only be used on the network.

The Quadnet network may be connected as shown below. The network may comprise of control panels or repeater panels as required, up to a maximum of 4 nodes. In addition to the connections shown, each panel will require a 230V AC supply and the power supply arrangements relevant to that panel.

Any network port at a control panel may be connected to any other network port at any other control panel. A list of these connections must be noted during termination as they will need to be configured to each control panel for correct operation.

The network connection circuit must be installed as a single ring, with a maximum cable length of up to 1km between network nodes.

All system wiring should be installed to comply with BS 5839: Pt1: 2002: Amendment 2: 2008 and BS 7671 (wiring regulations), along with any other standards relevant to the area or type of installation. A cable complying with the BS 5839: Pt1: 2002: Amendment 2: 2008: Category 1 (cables required to operate for prolonged periods during fire conditions) is required. This must be a 2-core 1.5mm² screened fire resistant cable (ie. MICC, FP200, Firetuff, Firecell, Lifeline or equivalent).

In order to protect against possible data corruption it is important to ensure the following points are adhered to:

1. The cable **screen between each network node (panel/repeater) must be connected to SCRN Terminal at one end only** using the terminals provided. Ensure that the end that is not connected is safely terminated in a connector block to avoid unwanted shorting to any other point.
2. Do not use a 4-core cable as a loop **feed & return** due to the possibility of data corruption. It is essential that two 2-core cables are used if this is required.
3. Excess cable lengths must not be coiled as coiling will increase the inductance and cause communication problems.

Network Cable Specification

Max Capacitance Core to Screen	180pF / m
Max Capacitance Core to Core.....	100pF / m
Max Inductance.....	1.0mH / km
Max Resistance Two Core Screened 1.5mm ²	12.1Ω / km
Fire Proof	BS5839: Pt1: 2002 Category 1
Example	Datwyler 8700

Network Connection Schematic

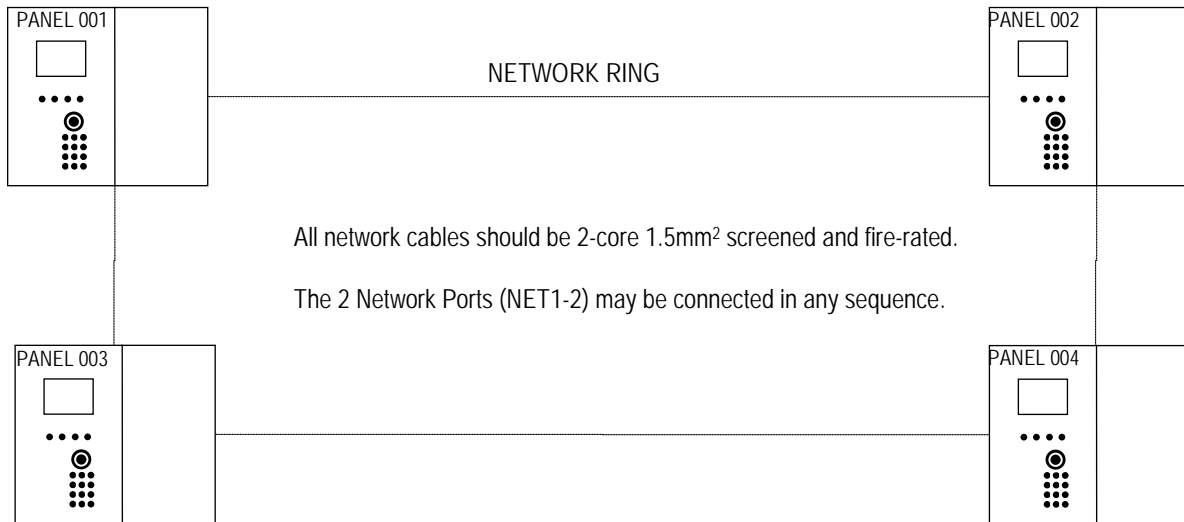

As shown above, the numbering of panels may be in any order. However, when planning an installation, it would make sense to number the panels sequentially in the order in which they are wired. The maximum number of networked units is 4. These can be a mixture of repeater panels and control panels.

Network Terminals

CONTROL PANEL MAIN PCB (Located on the inside of the front left hand inner door)

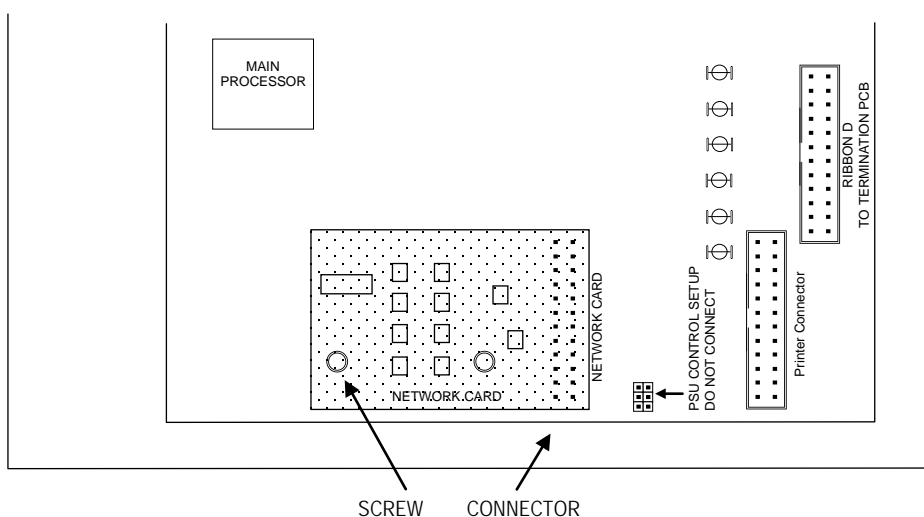

Before any networking facilities may be used, the optional Quadnet network card must be fitted to the control panel main PCB (CIE) as shown above.

Network cabling connects to the Network terminals on the backplane PCB.

Quadnet Control Panel Engineering and Commissioning Manual

All network cables should be 2-core 1.5mm² screened and fire-rated. The cable screen must be connected to the control panel (using the SCRNB terminal provided, not at any earthing point) at one end only using the terminals provided. Terminate the unused end in a connector block as shown below.

The 2 Network Ports (NET1-2) may be connected in any sequence between panels. Note your network connections for future reference whilst installing them,

Eg. Panel 001, Network Port 1 connected to Panel 004 Network Port 2

Note: Terminal blocks shown below where the screen is not connected to the panel are fitted to prevent the screen from shorting or touching other circuits.

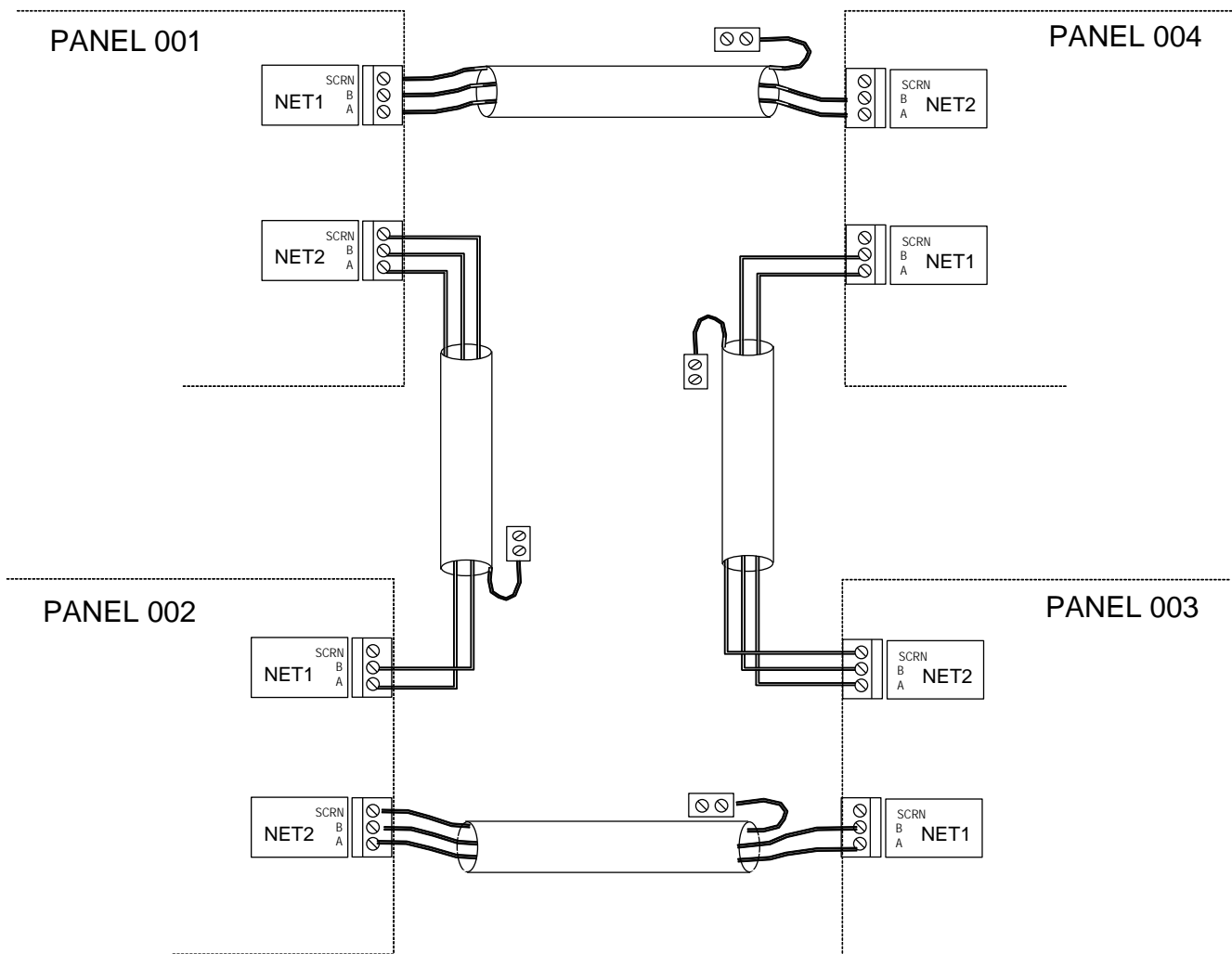

General Operation of Control Panel

Control Panel Front

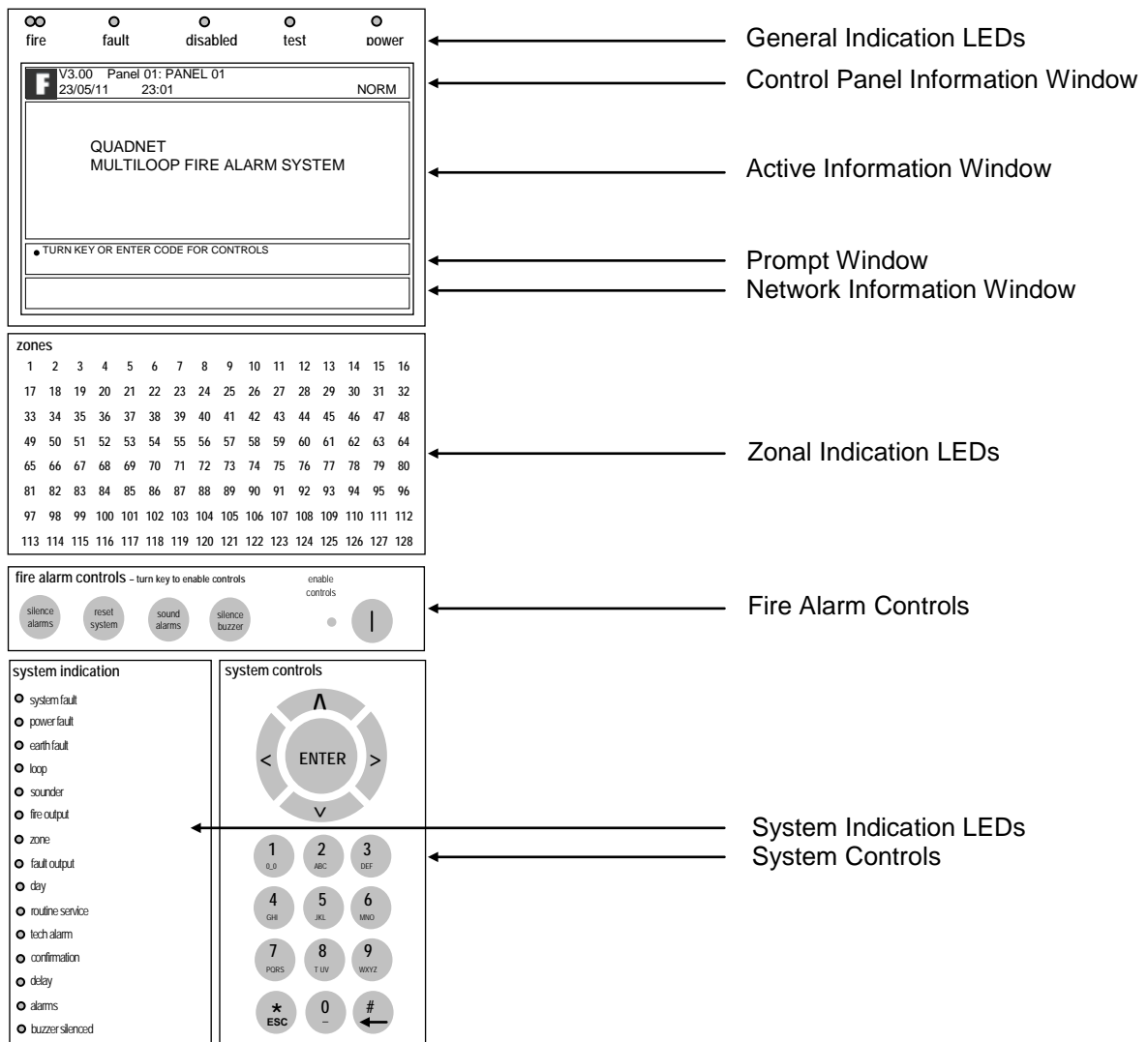

LED Indication

The operation of the LED indications on the front of the control panel is described below.

	Description	Colour	State	Reason
1.	FIRE	Red	Continuous	The control panel is in the fire state. Other indicators will show the origin
2.	FAULT	Yellow	Continuous	The control panel is in the fault state. Other indicators will show the origin
3.	DISABLED	Yellow	Continuous	This indicates that a disablement action is in place. Enable all devices / actions to clear.
4.	TEST	Yellow	Continuous	This indicates that a test routine is in place. End all tests to clear.
5.	POWER	Green	Continuous	This indicates that power is being supplied to the control panel from either the 230V AC mains supply, or the standby batteries.
6.	'ZONE 1-128'	Red	Flashing	A Manual Call Point in the zone indicated is in the alarm state and sending an alarm signal to the panel. A Detector in the zone indicated is in the alarm state and sending an alarm signal to the panel.
7.	SYSTEM FAULT	Yellow	Flashing	The system Fault LED indicates the presence of a processor or a checksum error. Power the system down to clear, reprogram all settings and test the system.
8.	POWER FAULT	Yellow	Flashing	The mains supply has failed (check the fuse and the 230V AC supply on the PCB AC terminals).
			Continuous	A battery supply / charger fault has been detected (check the fuse and the battery voltages).
9.	EARTH FAULT	Yellow	Flashing	An earth fault has been detected where a path exists from the circuit wiring to earth. Remove circuits one at a time to discover which one, and then rectify. An earth fault may also be reported while a PC is connected to the panel for diagnostics or programming. In this case, the earth fault should clear when the PC is disconnected.
10.	LOOP	Yellow	Flashing	A fault condition is present on one or more addressable device loops, or one or more addressable devices.
			Continuous	A device or an action associated with the addressable device loop has been disabled
11.	SOUNDER	Yellow	Flashing	A fault condition is present on a monitored sounder circuit or on the addressable device loop sounders.
			Continuous	A device or an action associated with the monitored sounder circuits or addressable sounders has been disabled.
12.	FIRE OUTPUT	Yellow	Flashing	A fault condition is present on a monitored Relay circuit or on the addressable device loop outputs.
			Continuous	A device or an action associated with the monitored relay circuits or an addressable output has been disabled.
13.	ZONE	Yellow	Continuous	A device or zone, or an action associated with them has been disabled.

Quadnet Control Panel Engineering and Commissioning Manual

14.	FAULT OUTPUT	Yellow	Flashing	A monitored output programmed to operate as a Fire Output is in the fault state.
			Continuous	A monitored output programmed to operate as a Fire Output has been disabled.
15.	DAY	Yellow	Continuous	The system Day / Night mode timing has been overridden, and forced into the less sensitive day mode. The system has gone in the less sensitive day mode as programmed.
			Continuous	The pre programmed service interval has expired and a routine maintenance check is due.
16.	ROUTINE SERVICE	Yellow	Continuous	
17.	TECHNICAL ALARM	Yellow	Continuous	A device programmed as Technical Alarm is in the alarm state and sending a Technical Alarm signal to the panel. No indication of a Technical Alarm is given on the display.
18.	CONFIRMATION	Yellow	Continuous	A smoke detector is in the alarm confirmation state, awaiting confirmation or reset.
19.	DELAY	Yellow	Continuous	An action has been started which utilises a programmed delay.
20.	ALARMS	Yellow	Flashing	The alarm sounders have been activated from the Sound Alarms button on the panel.
			Continuous	The alarm sounders have been silenced whilst operating, and the system is awaiting a reset.
21.	BUZZER SILENCED	Yellow	Continuous	The control panel buzzer has been silenced whilst operating and will stay silenced until another fault or relevant action occurs. The control panel buzzer has been disabled at Access Level 3 (Engineer), and will remain silent until it is reinstated. However, the buzzer will still operate in the fire alarm state.
			Continuous	

Fire Alarm Controls

The main Fire Alarm Controls may be enabled by turning the key switch to the controls enabled position, or by entering a valid Access code.

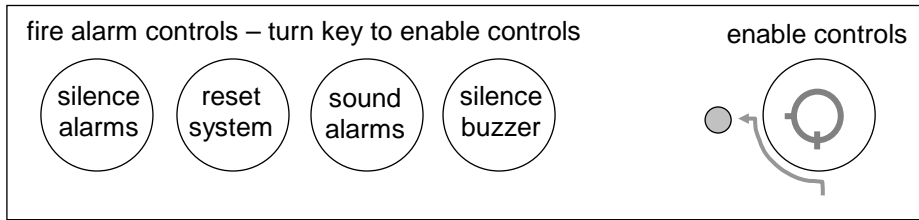

System Controls

User

1. Delay Override
2. Test Display

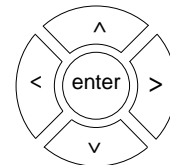

Supervisor

1. Delay On/Off
2. Test Display
3. View Logs
4. Disable/Enable
5. Set Time & Date
6. Test Modes
7. Day/Night Mode
8. Find Device



Engineer

1. View Logs
2. Test Display
3. Disable/Enable
4. Set Time & Date
5. Test Modes
6. Day/Night Mode
7. Engineer Controls

A context-driven highlighted-selection menu system is used to navigate the menu system, automatically prompting you with the relevant options for your Access Level and system status.

The menus may be navigated in one of two ways as required:

1. Use the **UP** / **DOWN** keys to move the highlighted selection and press **ENTER** to select the chosen one.
2. Enter the desired option number and press **ENTER** to select it.

Press the **Esc** key to exit to the previous menu.

Access Levels and Codes

The menu system is divided into four access levels in order to restrict access to those who require it. For simple indication the status of the **Controls Enabled** light will show the level selected as follows;

Access Level	Description	Shift LED	Key Operation	Default Code
1 – NORM	Normal	OFF	YES	N/A
2A – USER	User	ON	YES	8737
2B – SUPR	Supervisor	SLOW FLASH	NO	7877
3 – ENGR	Engineer	FAST FLASH	NO	3647

Access to the menu system requires either the operation of the **enable controls key** for access to Access Level 2A (User), or the correct entry of the relevant code for access to all other levels, in order to protect against unauthorised access to the system. The codes may be changed using the Quadnet OSP software.

A valid access level code must be entered in order access any of the menus.

Menu examples shown below are for the V3 control panel. Menus in some earlier panel versions may differ.

Access Level 1 (Normal): Controls Enabled LED off

At Access Level 1 (Normal), the main **Fire Alarm Controls** are disabled and the Controls Enabled LED is switched off.

A valid access level code must be entered in order access any of the menus.

Delay Override

To comply with EN54-2 Clause 7.11.1d, a non-delayed manual call point (MCP) should be located next to the CIE to override the delayed output by a manual operation.

Access Level 2A (User): Controls Enabled LED on

At Access Level 2A (User), the main **Fire Alarm Controls** are enabled, and the following **System Controls** are accessible:

1. Delay Override

Delay Override

The Delay Override function overrides any programmed delays.

2. Test Display

Test Display

The Test Display function causes the panel LEDs to illuminate, and the LCD screen to blacken, and the panel buzzer to sound in order to verify their correct operation.

Press the **Esc** key to exit to the previous menu.

Access Level 2B (Supervisor): Controls Enabled LED flashing slowly

At Access Level 2B (Supervisor), the main **Fire Alarm Controls** are enabled, and the following **System Controls** are accessible:

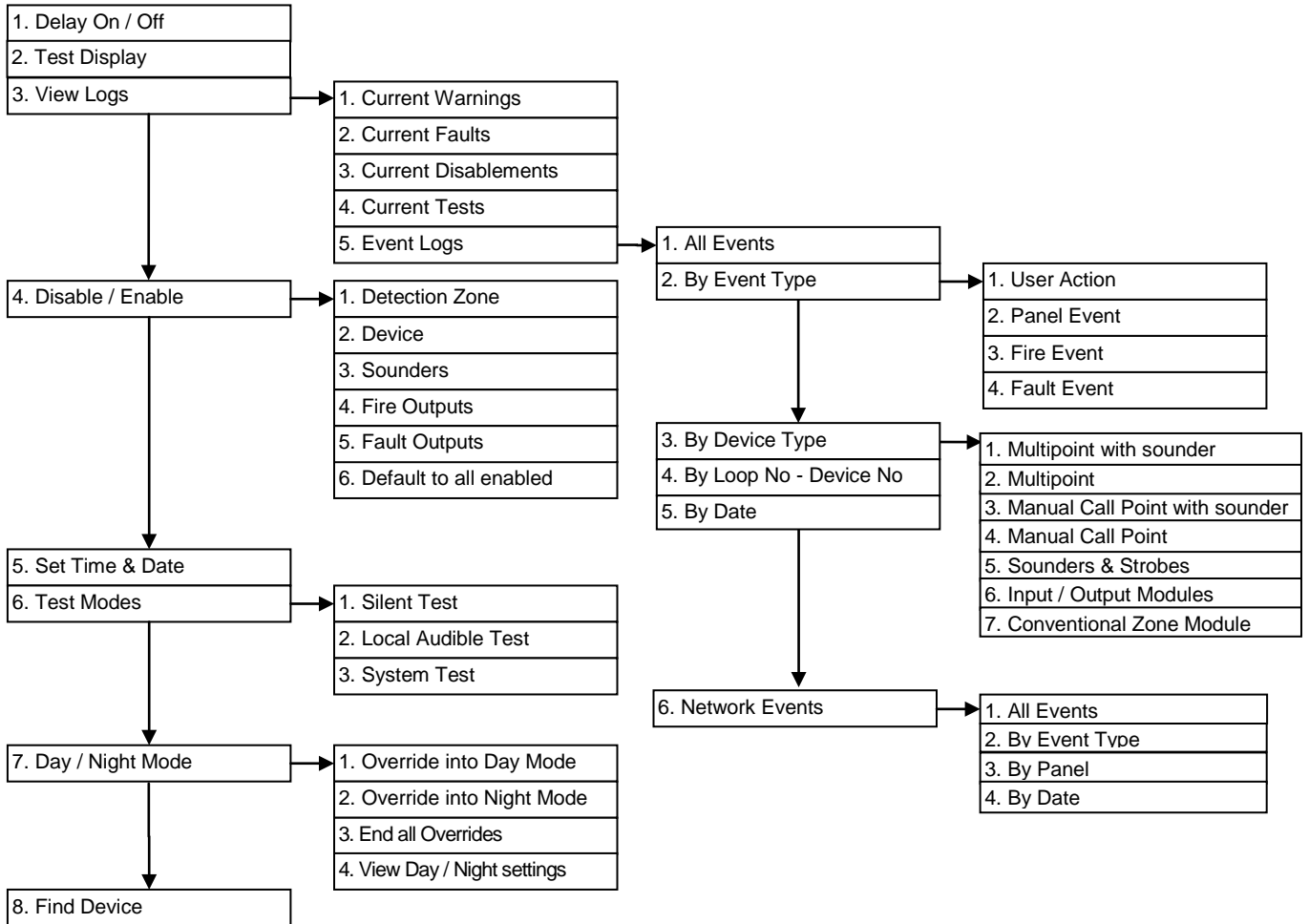

1. Delay On/Off

The Delay On/Off function allows pre-configured time delays to be over-ridden or re-instated manually as required, ie, if sounder operation within a chosen area is programmed to operate after a time delay, then this delay may be removed or replaced using this function.

2. Test Display

The Test Display function causes the panel LEDs to illuminate, the LCD screen to blacken and the panel buzzer to sound in order to verify their correct operation.

3. View Logs

1. Current Warnings

The Active Warnings Log will display any current warnings. These are displayed in text format and may be scrolled through by pressing the **UP** and **DOWN** keys.

3. View Logs

2. Current Faults

The Active Faults Log will display any current faults. These are displayed in text format and may be scrolled through by pressing the **UP** and **DOWN** keys.

3. View Logs

3. Current Disablements

The Active Disablement Log will display any current disablements. These are displayed in text format and may be scrolled through by pressing the **UP** and **DOWN** keys.

3. View Logs

4. Current Tests

The Active Tests Log will display any current test modes. These are displayed in text format and may be scrolled through by pressing the **UP** and **DOWN** keys.

3. View Logs

5. Event Logs

The Event Log stores 1000 local fire / fault events and 1000 network events which may be displayed in entirety, or displayed by category. These are displayed in text format and may be scrolled through by pressing the **UP** and **DOWN** keys.

4. Disable / Enable

1. Detection Zone

This function allows the disablement or enablement of a detection-zone. Thus, all the input devices (Manual Call Points, detectors and inputs) within that detection-zone will be disabled. The control panel will indicate that disablements are present, a disablement event will be recorded to log, the device LED will still operate when activated and an event will be recorded in the log, but no programmed actions will occur. The sounder within the device will still operate if triggered from elsewhere on the system.

4. Disable / Enable

2. Device

This function allows the disablement or enablement of an individual device. The control panel will indicate that disablements are present, a disablement event will be recorded in the log, the device LED will still operate when activated and an event will be recorded in the log, but no programmed actions will occur. The sounder within the device will still operate if triggered from elsewhere on the system.

4. Disable / Enable

3. Sounders

This function allows the global disablement or enablement of all the sounders on the system. The control panel will indicate that disablements are present and a disablement event will be recorded in the log.

4. Disable / Enable

4. Fire Outputs

This function allows the global disablement or enablement of all fire outputs on the system. The control panel will indicate that disablements are present and a disablement event will be recorded in the log.

4. Disable / Enable

5. Fault Outputs

This function allows the global disablement or enablement of all fault outputs on the system. The control panel will indicate that disablements are present and a disablement event will be recorded in the log.

4. Disable / Enable

6. Default to All Enabled

This function enables any device / action that may have been disabled, and all programmed actions are reinstated. The control panel event log will indicate that all actions have been reinstated.

5. Set Time and Date

This allows the time and date to be adjusted.

6. Test Modes

1. Silent Test

The Silent Test function allows the selection of one or more detection-zones to operate in a 'silent one-man walk test mode'. On triggering a device the device LED operates and the event is recorded in the event log as a test activation, but the sounder does not sound and the control panel does not show an alarm. After approximately 5 seconds the system will reset the device, and another may be tested. The control panel event log will indicate that a test mode has been selected.

6. Test Modes

2. Local Audible Test

The Local Audible Test function allows the selection of one or more detection-zones to operate in a 'one-man walk test mode with local sound'. On triggering a device the device LED operates, the sounder within that device operates and the event is recorded into the event log as a test activation, but the control panel does not show an alarm. After approximately 5 seconds the system will reset the device, and another may be tested. The control panel event log will indicate that a test mode has been selected.

6. Test Modes

3. System Test

The System Test function allows the entire system to operate in a simple one-man walk test mode. On triggering a device the device LED operates and the event is recorded in the event log, all the assigned sounders operate for 10 seconds and the control panel indicates an alarm. After approximately 10 second the system will reset the device, and another may be tested. The control panel event log will indicate that a test mode has been selected.

Please note, with the system test mode, only the sounders assigned to operate from that device will sound, and any delays will still be present. ie. if a delay of 2 minutes is present, the system will have been reset before the sounders activate.

7. Day / Night Mode

1. Override into Day Mode

This function allows the user to override any pre-programmed Day / Night timing information and force the system into the less sensitive Day Mode. This will cause the panel buzzer to sound and a disablement to be written to log.

7. Day / Night Mode

2. Override into Night Mode

This function allows the user to override any pre-programmed Day / Night timing information and force the system into the more sensitive Night Mode. This will cause the panel buzzer to sound and a disablement to be written to log.

7. Day Night Mode

3. End all Overrides

This function ends any override on the Day / Night Mode, and all programmed actions are reinstated. The control panel event log will indicate that all actions have been reinstated

7. Day Night Mode

4. View Day / Night Setting

This function allows the user to view the start and finish times for each day.

8. Find Device

This function allows the user to switch on the LED and sounder (if they are present) at any device on the loop in order to aid in locating its position. It cannot be used to turn on the LED of I/O Modules, since this would also turn on the output which would not usually be desirable.

Up, Down and Esc options allow the adjacent devices to be located, and the test to be ended.

Access Level 3 (Engineer): Controls Enabled LED flashing quickly

At Access Level 3 (Engineer), the main **Fire Alarm Controls** are enabled, and the following **System Controls** are accessible:

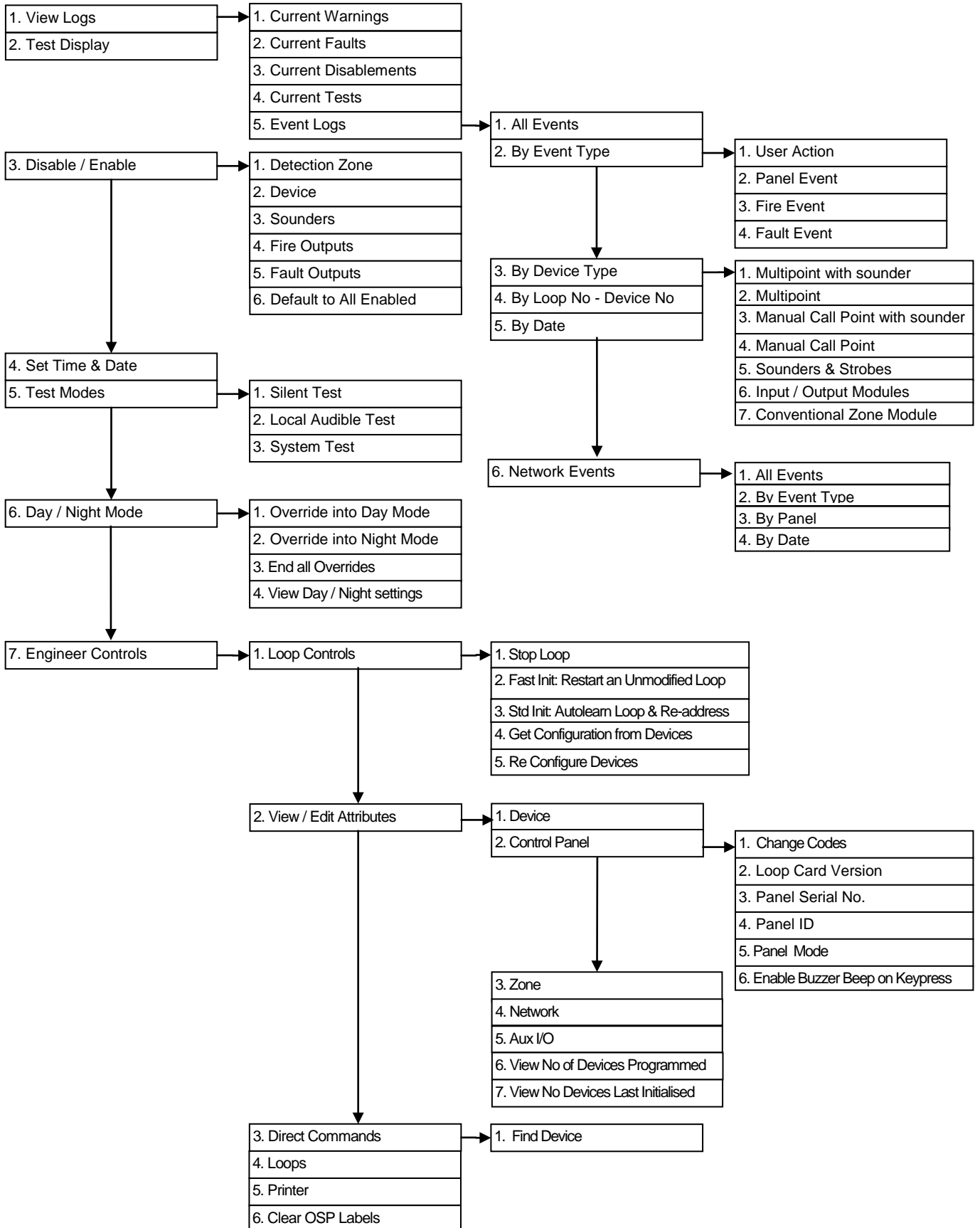

1. View Logs

1. Current Warnings

The Active Warnings Log will display any current warnings. These are displayed in text format and may be scrolled through by pressing the **UP** and **DOWN** keys.

1. View Logs

2. Current Faults

The Active Faults Log will display any current faults. These are displayed in text format and may be scrolled through by pressing the **UP** and **DOWN** keys.

1. View Logs

3. Current Disablements

The Active Disablement Log will display any current disablements. These are displayed in text format and may be scrolled through by pressing the **UP** and **DOWN** keys.

1. View Logs

4. Current Tests

The Active Tests Log will display any current test modes. These are displayed in text format and may be scrolled through by pressing the **UP** and **DOWN** keys.

1. View Logs

5. Event Logs

The Event Log stores 1000 local fire / fault events and 1000 network events which may be displayed in entirety, or displayed by category. These are displayed in text format and may be scrolled through by pressing the **UP** and **DOWN** keys.

2. Test Display

The Test Display function causes the panel LEDs to illuminate the LCD screen to blacken and the panel buzzer to sound in order to verify their correct operation

3. Disable / Enable

1. Detection Zone

This function allows the disablement or enablement of a detection-zone. Thus, all the input devices (Manual Call Points, detectors and inputs) within that detection-zone will be disabled. The control panel will indicate that disablements are present, a disablement event will be recorded in the log, the device LED will still operate when activated and an event will be recorded in the log, but no programmed actions will occur. The sounder within the device will still operate if triggered from elsewhere on the system.

3. Disable / Enable

2. Device

This function allows the disablement or enablement of an individual device. The control panel will indicate that disablements are present, a disablement event will be recorded in the log, the device LED will still operate when activated and an event will be recorded in the log, but no programmed actions will occur. The sounder within the device will still operate if triggered from elsewhere on the system.

3. Disable / Enable

3. Sounders

This function allows the global disablement or enablement of all the sounders on the system. The control panel will indicate that disablements are present and a disablement event will be recorded in the log.

3. Disable / Enable

4. Fire Outputs

This function allows the global disablement or enablement of all fire outputs on the system. The control panel will indicate that disablements are present and a disablement event will be recorded in the log.

3. Disable / Enable

5. Fault Outputs

This function allows the global disablement or enablement of all fault outputs on the system. The control panel will indicate that disablements are present and a disablement event will be recorded in the log.

3. Disable / Enable

6. Default to All Enabled

This function enables any device / action that may have been disabled, and all programmed actions are reinstated. The control panel event log will indicate that all actions have been reinstated.

4. Set Time and Date

This allows the time and date to be adjusted. These settings will need to be re-entered after the complete removal of power, as the system will simply resume from the point that power was removed.

5. Test Modes

1. Silent Test

The Silent Test function allows the selection of one or more detection-zones to operate in a 'silent one-man walk test mode'. On triggering a device the device LED operates and the event is recorded in the event log as a test activation, but the sounder does not sound and the control panel does not show an alarm. After approximately 5 seconds the system will reset the device, and another may be tested. The control panel event log will indicate that a test mode has been selected.

5. Test Modes

2. Local Audible Test

The Local Audible Test function allows the selection of one or more detection-zones to operate in a 'one-man walk test mode with local sound'. On triggering a device the device LED operates, the sounder within that device operates and the event is recorded in the event log as a test activation, but the control panel does not show an alarm. After approximately 5 seconds the system will reset the device, and another may be tested. The control panel event log will indicate that a test mode has been selected.

5. Test Modes

3. System Test

The System Test function allows the entire system to operate in a simple one-man walk test mode. On triggering a device the device LED operates and the event is recorded into the event log, all the assigned sounders operate for 10 seconds and the control panel indicates an alarm. After approximately 10 second the system will reset the device, and another may be tested. The control panel event log will indicate that a test mode has been selected.

Please note, with the system test mode, only the sounders assigned to operate from that device will sound, and any delays will still be present. ie. if a delay of 2 minutes is present, the system will have been reset before the sounders activate.

6. Day / Night Mode → **1. Override into Day Mode**

This function allows the user to override any pre-programmed Day / Night timing information and force the system into the less sensitive Day Mode. This will cause the panel buzzer to sound and a disablement to be written to log.

6. Day / Night Mode → **2. Override into Night Mode**

This function allows the user to override any pre-programmed Day / Night timing information and force the system into the more sensitive Night Mode. This will cause the panel buzzer to sound and a disablement to be written to log.

6. Day Night Mode → **3. End all Overrides**

This function ends any override on the Day / Night Mode, and all programmed actions are reinstated. The control panel event log will indicate that all actions have been reinstated

6. Day Night Mode → **4. View Day / Night Setting**

This function allows the user to view the start and finish times for each day.

7. Engineer Controls → **1. Loop Controls** → **1. Stop Loop**

This function performs a complete shutdown of every device on the chosen loop. To ensure that every device is properly shutdown, it is important to stop the loop before removing power from the loop. If this is not done, it may cause random faults and stoppages during subsequent initialisation. The loop must also be stopped before removing/adding/replacing devices. Should problems occur during initialisation, stop the loop and wait for approximately five minutes before initialising the loop again. The previously improperly shutdown device should reboot successfully.

7. Engineer Controls → **1. Loop Controls** → **2. Fast Init**

This function may be termed Fast Initialisation, and is only suitable for restarting the loop if the loop configuration has not been altered in any way. Always wait at least 3 minutes between stopping a loop and reinitialising.

7. Engineer Controls → **1. Loop Controls** → **3. Std Init: Autolearn Loop**

This function instructs the control panel to perform its addressable circuit initialisation, or to autolearn the loop devices. Previous loop map data is overwritten, so only perform this function on new systems where a complete configuration reprogram will be completed. It starts this process from Circuit End 1 and collects data on device type, position & serial number, and allocates a Device Address. Please note that even though this panel does not support spurs, the control panel will still check for their presence. Always wait at least 3 minutes between stopping a loop and reinitialising.



The control panel processor memory holds all the system configuration and programming details. Certain aspects such as device description, zoning and 'cause & effect' are operated from that point. However, whilst individual device attributes such as smoke mode, heat mode, sound pattern and volume are stored in the control panel, they need to be stored in the processor memory within the device to be operational. The get configuration command collects the configuration from the loop devices to be stored at the control panel.

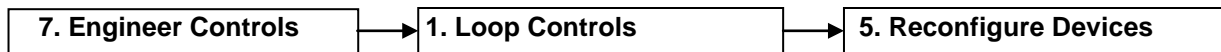

The control panel processor memory holds all the system configuration and programming details. Certain aspects such as device description, zoning and 'cause & effect' are operated from that point. However, whilst individual device attributes such as smoke mode, heat mode, sound pattern and volume are stored in the control panel, they need to be stored in the processor memory within the device to be operational. This is carried out with the reconfigure command, which sends out all the relevant data to the loop devices.

Note that the system should always be re-configured after a PC download from Quadnet OSP, and then the system should be reset using the 'reset' button. If this is not carried out the system may give a Configuration Data Error fault.



This function allows the user to view, and edit if required, the attributes for each loop device. These attributes include the device type, serial number, address, zone, description, input, output, detection and alarm information. You may also read the optical and heat standing levels for Multipoint detectors. If changes are made, the individual device may be reconfigured to save the longer task of reconfiguring all devices on that loop.



This function allows the user to view, and edit if required, the attributes for the control panel. These attributes include Access Codes, Loop Card software version, panel serial number, panel ID, panel mode and key press tone. You may also read the control panel serial number and software version

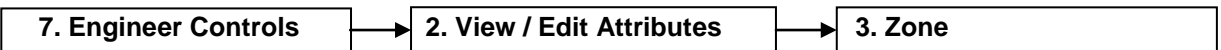

This function allows the user to view, and edit if required, the attributes for each zone. These attributes include the description, and alarm confirmation information.



This function allows the user to view, and edit if required, the attributes for the system network programming. These attributes include response and transmission of network information (for fire, fault, control and technical events), control panel network connections, network ID and Description.



This function allows the user to view and edit the attributes of the auxiliary inputs and outputs connected to the system.

7. Engineer Controls

→ 2. View / Edit Attributes

→ 6. View no. of Devices Programmed

This function allows the user to view the loop devices programmed and compare with the loop devices present.

7. Engineer Controls

→ 2. View / Edit Attributes

→ 7. View no. of Devices in Last Init

This function allows the user to check the number of devices initialised on the system.

7. Engineer Controls

→ 3. Direct Commands

→ 4. Find Device

This function allows the user to switch on the LED and sounder (if they are present) at any device on the loop in order to aid in locating its position. It cannot be used to turn on the LED of I/O Modules, since this would also turn on the output which would not usually be desirable.

Up, Down and Esc options allow the adjacent devices to be located, and the test to be ended.

7. Engineer Controls

→ 4. Loops

This function allows the user to switch on or off any used or unused loops. Please ensure that any loop cards in use are fitted and switched on.

7. Engineer Controls

→ 5. Printer

This function allows the engineer to change printer settings for the optional onboard printer and to print various reports on demand.

The engineer can turn printing on or off. If printing is turned on, the engineer can select which local events get printed 'live' (all events, or any combination of one or more of the following: fires, faults, panel events).

The engineer can also manually print out

- the event log (either all events or a selection by range)
- device configuration (one device on a selected loop or all devices on a selected loop)
- a printer test
- a list of current warnings
- a list of current tests
- a list of current faults
- a list of current disables

7. Engineer Controls

→ 6. Clear All OSP Labels

WARNING: This function will erase all device labels from the system.

Printer

Quadnet control panels can have an optional printer fitted if required. This must be specified when ordering a panel and cannot be fitted by the end user or installer as an after market addition. If the printer is fitted it can be setup to print out local events as they occur. The engineer can configure during commissioning which local events get printed (fires and/or faults and/or panel events).

Paper out

The printer will automatically detect when the printer paper has run out. The Status indicator LED will flash repeatedly.

Fitting a new roll of paper

The paper used in the printer is Fike Part No 507-0016. No other paper should be used.

- The printer paper can be accessed by lifting the front cover on the printer.
- Use the paper feed button (located on the right hand side opposite the Status indicator LED) to feed through the last few centimetres of paper.
- Fit a new paper roll onto the carrier. The printer incorporates an automatic paper feed facility. With a new paper roll mounted on the carrier and with a clean straight edge to the paper, present the paper to the entry point behind the rubber roller. The paper will be sensed by the mechanism and automatically feed through into a position ready for printing.
- Use the paper feed button to feed more paper through if required.

Specification:

Printing system	Thermal line head
Max characters per line	48
Character matrix (dots)	24x16, 24x12 or 24x8
Character size	3x2, 3x1.5 or 3x1mm (Approx. 13, 17 or 25cpi)
Dot pitch horizontal	0.125mm (Approx. 200dpi)
Dot pitch vertical	0.125mm
Text line composition	(dots) 24x384
Printing width	48mm
Paper width	58 mm (+0 / -1)

Alarm Confirmation Technology

Alarm Confirmation Technology (ACT) is the process whereby a smoke detector may be configured to issue a localised warning in specific regions, prior to sounding a general alarm. This is generally of great benefit in dwelling areas where smoke, steam or cooking fumes may trigger a Multipoint detector.

The following drawing demonstrates some of the possibilities:

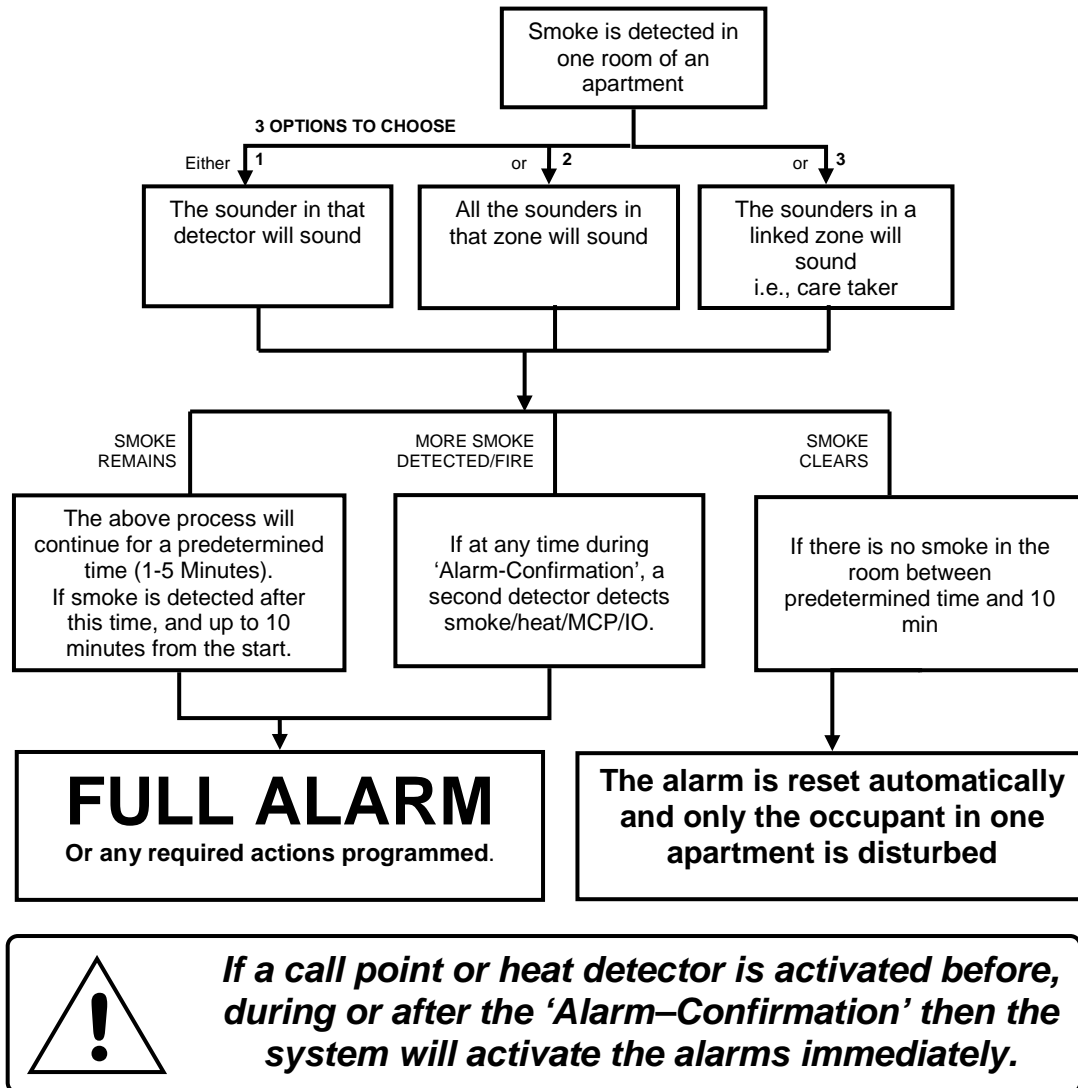

This function affects the smoke detector only, and operates before the control panel enters the Fire state. Thus, the system 'Cause & Effect' does not need to be adjusted, as **Alarm Confirmation takes place before the programmed Cause & Effect sequence is reached.**

This function requires the use of a PC with Quadnet OSP and it is not possible to use it without. In order to activate the function, install the devices as normal and refer to the Quadnet OSP Programming Manual for further details.

Alarm Confirmation Delay

The **Alarm Confirmation Delay** timer allows an automatic reset of an unconfirmed alarm from a smoke detector.

When a smoke detector using Alarm Confirmation is activated, the sounder within that device (or all the sounders in the zone) will activate with the sound pattern selected for Alarm Stage 1 (Alarm Confirmation). This warning sound may also be copied to any additional zone, and may also be displayed on the control panel if required.

At the end of the Alarm Confirmation Delay time the system will check the detector again to see if the activation has cleared. If so then the device will reset and no further action need be taken.

The sounder operates during the chosen Alarm Confirmation Delay time, and stops for the final 20 seconds, during which time the device is reset to check for further smoke presence.

During the Alarm Confirmation Delay, the activation of an additional smoke detector into **Alarm Confirmation** will cause the delay time to cease and an instant alarm to be generated.

If, however, the detector is still in alarm then the entire system will go into alarm, operating all the sounders programmed in the Cause & Effect area.

For a further time period (10 min minus Alarm Confirmation Delay), the activation of the smoke detector will cause an immediate alarm (depending on the programming of the system Cause & Effect).

The activation of any Heat detector (even in the same device as the smoke detector in Alarm Confirmation) generates an immediate alarm (depending on the programming of the system Cause & Effect).

Selecting the Devices

Any smoke detectors which are to utilise **Alarm Confirmation** must be selected using the Quadnet OSP programming software. Smoke detectors not selected will operate in a standard manner (depending on the programming of the system **Cause & Effect**).

An **Alarm Stage 1 (Alarm Confirmation)** sound pattern must also be selected, and this may be set to a different sound pattern to that chosen in **Alarm Stage 3 (Evacuate)** in order to provide an audible difference between alarm stages.

The activation of any smoke detector set for Alarm Confirmation causes the sounder within that device only to operate (or across the entire zone if required), but no indication shows on the control panel. This warning sound may also be copied to any additional zone, and may also be displayed on the control panel if required.

The activation of any Heat detector (even in the same device as the smoke detector in Alarm Confirmation) generates an immediate alarm (depending on the programming of the system Cause & Effect).

Commissioning

Installation 1st Stage

The installer needs to install the system wiring in the form of 2-core and screen loops returning to the control panel

The cabling should be 2-core 1.5mm², screened and fire resistant, of an MICC or FP200 equivalent type. 4-core cable must not be used as a loop 'feed & return' due to the possibility of data corruption.

The loop should be left as a complete loop with no devices connected, and must be tested and documented for conductor continuity and for insulation integrity, with a high voltage tester as required for general electrical installations. If using legacy Sita Multipoint detectors, use the shorting links provided within each base to provide continuity in the positive core.

The control panel back box should be mounted, with the mains supply tested, connected and isolated at the un-switched fused spur, ready for the commissioning engineer.

The installer needs to provide a set of **As-Wired** drawings, completed **configuration sheets** and proof of **loop continuity and insulation test readings** etc., to enable commissioning to proceed. This information is essential for commissioning and programming to proceed, and may be entered onto the forms provided at the rear of the manual.

Installation 2nd Stage

Once the commissioning engineer is satisfied with the continuity / integrity of the loop, the devices may be installed, noting the serial numbers for each device on the configuration sheets.

NB. *Ensure that the next section, 'Initialisation', is read and understood before the devices are installed.*

Initialisation

The addressable device loops may now be initialised. This is when the control panel interrogates the loops one device at a time, for type, serial number and position, before allocating a loop address number. Initialisation is carried out from the control panel keypad by utilising one of the three loop initialisation commands located within the Access Level 3 (Engineer) menu.

Install one device (and note its serial number as normal), as near to the control panel as possible and initialise the system. If initialisation fails the problem may be tracked quickly, and if needs be the device is easily removed to facilitate further high voltage testing. If the device appears to be at fault then try another Electronics Module and reinitialise. If this has no effect, then check terminations carefully and inspect the connector carefully for damage. Further to this a common fault on installations utilising existing cabling is the omission to remove old incompatible devices. Once the system is initialised and happy with its single device then proceed as below.

Add the rest of the devices in batches of 10-25, initialising each time to prove correct operation. If a fault is found, or initialisation fails, then the relevant batch of devices may be partially removed and added in smaller numbers until the problem is tracked.

Note: **There is no need directly to initialise in sections in this manner, but we recommend this method as good engineering practice, in order to provide a controlled process of building up the system in sections.**

The system can only indicate faults present when the loop is fully initialised. If the initialisation fails then you will need to find faults manually. You may run the initialisation backwards by reversing the loop connections, or one ended by removing one end of the loop. You may also use the Quadnet OSP software

to identify which devices have been found and initialised. Noting how far the device count on the control panel screen reached will indicate many faults, such as open or short circuit. Further more the sounders may be operated from the control panel to indicate which devices are operational, or the LEDs may be switched on using the appropriate Fike Loop Diagnostic software.

Please note that even though this panel does not support spurs, the control panel will still check for their presence.

Commissioning

Commissioning the Quadnet system involves programming and testing the system.

Whilst the software may be pre-configured before arriving at site if required (from the **as-wired** drawings and the configuration sheets), it is generally simpler and quicker if the site configuration is uploaded and altered directly whilst still on site, as the system will have found much of its configuration upon initialisation.

If the configuration is written before upload from the control panel, then the software is termed a 'New file', and does not contain the entire loop information required (which the control panel acquires on initialisation). This may then be merged on site to give a full configuration file termed an 'Old file'.

A comparison of serial numbers between the drawings/config sheets and the OSP upload is always recommended to prove the actual device order as opposed to the assumed device order.

Normally, commissioning will take place as follows:

1. Initialise the addressable device loops.
2. Upload the configuration from the control panel to the PC with Quadnet OSP.
3. Check that the addressable device serial numbers are in the positions on the loops that were expected, amend the configuration to suit the site and check it carefully.
4. Download the configuration from the PC to the control panel.
5. Initialise the loops.
6. Reconfigure the addressable devices with the Reconfigure command at Access Level 3 (Engineer).
7. Reset the system
8. Test for correct operation.

NOTE: It is imperative that the correct version of OSP is used to match your version of Quadnet control panel. The use of an incompatible version may result in incorrect operation of the control panel. In particular, do not use a V2.xx series OSP with a V3.xx series control panel and do not use a V3.xx series OSP with a V2.xx series control panel.

When the system is correctly programmed it must be tested for correct operation. It is important to remember that a Point Test mode is a service tool and not a commissioning tool, as the complete 'cause and effect' of the system is not tested.

The System Test function allows the control panel to be completely activated as normal, before the control panel automatically silences and resets the system. However it is recommended that a new system is commissioned live, with all sounders active in order to prove correct operation of every device whenever a system is programmed in any other way than a simple 'One off, all off' configuration.

It is essential that every device is tested in every selected mode of operation, and that all programmed actions are observed for correct operation. This includes the smoke testing of smoke detectors, heat testing of heat detectors, testing of Manual Call Points, testing of all inputs, testing of all sounders and outputs, and fault testing of detectors by head removal (not possible with ASD).

We also recommend that all devices, which are set to 'heat only', are tested for smoke operation, to ensure that the smoke detection has been correctly disabled.

Configuration Example

From your 'As-Wired' drawings device addresses can be assigned, starting from circuit end 1.

From this the device attributes may be filled out on the configuration sheets, as shown in the following example:

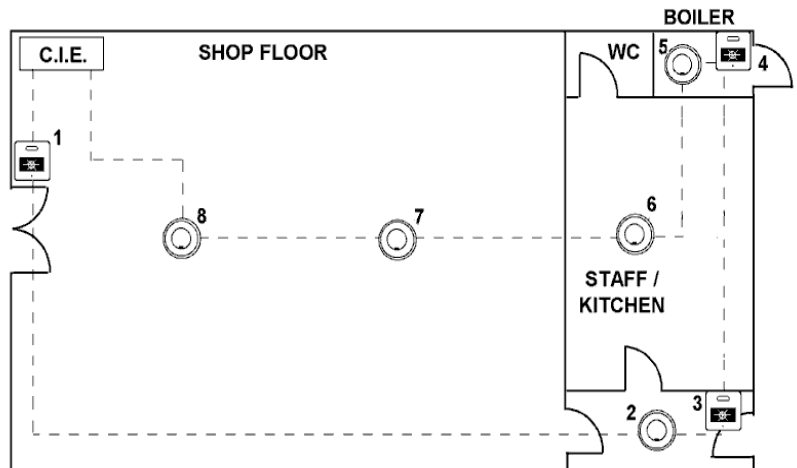

Control Panel No.: 01		Loop No.: 1					
Description: West Wing		Description: Ground Floor					
DEVICE ADDRESS	SERIAL NUMBER	DEVICE DESCRIPTION (24 CHARACTERS MAX)	ZONE	DEVICE TYPE	SMOKE MODE	HEAT MODE	ALARM CONF'N
1	212	Shop Floor: Main Entrance	1	MCP	-	-	-
2	30960	Staff Area: Rear Lobby	1	MPS	SM2	HM2	-
3	213	Staff Area: Rear Exit	1	MCP	-	-	-
4	214	Boiler Room	2	MCP	-	-	-
5	30959	Boiler Room	2	MPS	SM0	HM3	-
6	30962	Staff Area: Kitchen	1	MPS	SM0	HM2	-
7	30963	Shop Floor: Rear	1	MP	SM2	HM2	-
8	30961	Shop Floor: Front	1	MPS	SM2	HM2	-

These details may then be entered into the Quadnet OSP programming software in order to program the operation of the system.

End User Training

A Fire Alarm System is of little use if the end user and/or the responsible persons who will be present in the building do not know how to operate and respond to the system. It is therefore essential that commissioning includes training for the users of the system and responsible persons.

User instructions and a Zone Chart should be left adjacent to the control panel. As access to the system must be controlled by responsible persons, it would be unusual to display the access codes on this notice. These codes must however be available for the responsible persons, so ensure that they are notified correctly.

The Quadnet User Guide should be explained and left with the responsible person on site, for storage in an accessible and known location, in order that the responsible person and the service engineer may keep information records up to date.

Good Practice

The following suggestions are good practice if carried out during commissioning, and may help avoid common problems at a later date. The Fike Safety Technology Technical Support department may be unable to assist if the information is unavailable, and the guidelines not followed.

Number of Devices

Make a clear note in the control panel back box in a conspicuous position of the number of devices on the system.

In the event of any future visits to site it will be clear how many devices are expected if the system is initialised. Without knowing this it is not possible to be sure that all devices have initialised correctly.

Label the Loop Ends

Make a clear note on the Loop cables adjacent to the terminal block to show **LOOP END 1** and **LOOP END 2**.

Thus, if the addressable device loop is reversed for any reason it will be plainly visible from the labels.

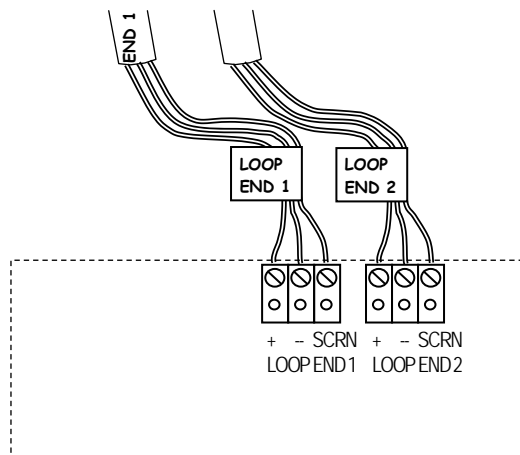

Note the Loop Readings

Make a clear note in the control panel back box of the loop continuity and insulation resistance readings, including those for the screen and mains earth.

These are then available for fault finding at a later date, ie.,

Date	+/+	-/-	Scr/Scr	+/-	+/Scr	-/Scr	Earth/Scr	Engineer
23/04/04	9.7	9.6	6.3	OL	OL	OL	OL	J Williams
31/04/05	10.3	10.2	6.4	OL	OL	OL	OL	T Roberts

Configuration Printout and Drawings

Make a **Text Report** printout of the system configuration from Quadnet OSP and store it safely on site along with an up to date site plan marked with devices, serial numbers and wiring order.

If any return visits are necessary all the relevant information on the system will be available without having to carry out an Upload of data to the PC. This includes address, serial number, device configuration and zonal configuration data.

Initialisation

Normal Readings

Ensure that your addressable device loop has the correct continuity and insulation integrity. With an electronic test meter there should be a continuity reading of approximately 1.2 ohms per 100m of 1.5mm² cable, and no continuity should be read between cores.

With the loop stopped and the loop connector block removed from the control panel, measure the continuity between **Loop End 1 –ve** and **Loop End 2 –ve**. There should be a maximum resistance of approximately 24 ohms, equating to approximately 1.2 ohms per 100 metres.

Likewise measure the continuity between **Loop End 1 Scrn** and **Loop End 2 Scrn**. There should be a maximum resistance of approximately 24 ohms, and this reading will normally be slightly lower than that of the **Loop –ve** continuity, due to the greater surface area of the screen. Screen integrity is of critical importance.

A measurement of the continuity between **Loop End 1 +ve** and **Loop End 2 +ve** should show a very high resistance, as the isolator within each device only provides continuity when energised by the control panel.

Measuring the insulation resistance between the **Loop –ve** and the **Loop Screen** should show no continuity. Remember that a low voltage electronic test meter should be used, and its accuracy is likely to be low when measuring high resistances, but this will give enough information to show insulation integrity.

Do not use a high voltage insulation test meter whilst any devices or the control panel are connected as they will suffer damage.

Initialisation Process

When the control panel is powered up the following LEDs will be continuously on, and the addressable device loop must be initialised at Access Level 3 (Engineer).

DISABLED ● and ● LOOP FAULT/DISABLED

During initialisation, a screen similar to the following will be displayed.

STANDARD INITIALISATION							
Loop	Loop Card	Loop Dev Init		Spur Dev Init		Init Complete	
1	ON	23	✓	0	✓	23	✓
2	ON	35	X	0	✓	35	X
3	NO	0		0		0	
4	NO	0		0		0	

The Loop Card status will be as follows:

ON Loop card assigned and present
 NO Loop card not assigned

The number shown under **Loop Dev Init** gives a count of the number of devices initialised on the loop. If the loop is found to be complete this is followed by a tick, whereas if the loop is found to be incomplete this is followed by a cross.

The number shown under **Init Complete** gives a count of the total number of devices initialised on the system. If initialisation is completed correctly this is followed by a tick, whereas if there is any failure in initialisation this is followed by a cross.

In normal initialisation conditions the control panel will start from Loop end 1, find, interrogate and address each device on the loop one at a time. When the second end of the loop is reached the control panel will display a tick or cross as shown above to indicate whether or not a complete loop was found.

Finally the control panel will investigate any spur connections from Multipoint detectors. Spurring was a feature in earlier panels and devices which allowed up to 5 devices to be spurred from a Multipoint detector over a 20m distance (total). The overall maximum permissible cable distance of 2km for an addressable circuit included both the main loop and any such spur runs and up to 5 spur runs were permitted on the system. This feature is no longer supported in current panels and devices. Even though spurs are no longer supported, the devices are still checked as part of the initialisation process for the presence of spurs. The **Spur Dev Init** column should indicate that no spurs are present on the system. If all devices are checked and no spurs are found a tick should be shown. However, if the panel found any spurs during this process, then even if initialisation has completed and a tick is shown, the loop should be stopped and the spurred devices rewired into the main loop.

When all possible devices have been initialised the control panel will indicate either that initialisation is complete or not, and the number of devices found.

The following LEDs will be extinguished (as long as no other faults exist).

DISABLED and LOOP FAULT/DISABLE

Or:

The following LEDs will remain on:

DISABLED and LOOP FAULT/DISABLE

After initialising the loop and pressing ESC to exit the STANDARD INITIALISATION screen, if the number of devices initialised does not match the number of devices programmed, a DEVICE QUANTITY MISMATCH screen will appear. This screen will give details of the number of devices found and the number of devices programmed.

Note that if the panel is new, a device quantity mismatch is likely because the panel will have been tested in the factory with various configurations and will have remembered the final test configuration.

Initialisation Faults

Device Quantity Mismatch

A device mismatch will occur if a device or devices have been physically removed from or added to the system and these changes have not been updated in the OSP and downloaded into the panel. The panel will be expecting to find the original number of devices which were downloaded to it. Check the site information to see if any changes have taken place and compare this with the OSP file.

Another cause could be that the loop was initialised too quickly after it was stopped. If a device has not powered down completely it may be missed when the loop is initialised causing a mismatch. Stop the loop and wait at least 5 minutes before reinitialising again.

Loop +ve to -ve Short Circuit Loop +ve Open Circuit

If the system faces a **Loop +ve to -ve short circuit**, or a **Loop +ve open circuit** during initialisation, the initialisation will fail at that point and a message of **Loop not complete** will be displayed.

All devices up to that point will be operational, but devices beyond will not be active, as the control panel will not initialise from Loop End 2 as it becomes very difficult to understand fully where the problem lies.

The active faults list in Access level 2B (Supervisor) and Access Level 3 (Engineer) and will display messages accordingly. These messages need to be viewed together as a complete set.

The control panel cannot determine the location of a short circuit, so a short circuit message will be followed by the location of the open circuit which is created when the isolator in that device responds to the short circuit.

Eg. Loop s/c and Loop o/c at device 'X'

Thus in the **Loop +ve to -ve short circuit** example shown previously, the initialisation will reach device 1 and fail thereafter. Thus the problem is after that point.

An investigation of the next device (device X+1) will determine if a correct loop voltage of approximately 40V DC has reached that point. If this has happened then the problem lies in either the connections at that point (device X+1) or a faulty electronics module (device X+1).

If the correct loop voltage of approximately 40V DC is not present at the next device (device X+1) then stop the loop and investigate device X. The problem may be due to an incorrect connection, a cable fault or a faulty electronics module.

If it is suspected that a device electronics module or device is faulty then try linking that device out (link the +ve cores together) and reinitialising the loop. If the initialisation then passes that point the device may be replaced. It is not advisable to leave a system with a device missing (positive cores linked together) in this way as all successive devices will be displaced.

The loop must be re-initialised to clear this fault.

Please note: A short circuit between cores with a value of between 3K and 300 ohm can cause corruption of the data on the loop and although no Short Circuit fault is reported the system integrity will be compromised.

Loop -ve Open Circuit

If the system faces a **Loop -ve open circuit** during initialisation, the initialisation will not fail at that point, but continue as normal to the end of the loop. All devices will be operational (as long as no other faults exist).

A message of **Addressable circuit: -ve open circuit** will be displayed, but the control panel cannot detect where the open circuit fault is located.

In order to locate the fault position, stop the loop, disconnect Loop end 2, wait at least 3 minutes and then reinitialise the system. The initialisation will fail at that point and a message of **Loop not complete** will be displayed.

Thus in this **Loop -ve open circuit** example, the initialisation will reach device X+1 and fail there. Thus the problem is after that point.

An investigation of the next device (device X+2) will determine if a correct loop voltage of approximately 40V DC has reached that point. If this has happened then the problem lies in either the connections at that point (device X+2) or a faulty electronics module (device X+2).

If the correct loop voltage of approximately 40V DC is not present at the next device (device X+2) then stop the loop and investigate device X+1. The problem may be incorrect connection, a cable fault or a faulty electronics module.

If it is suspected that a device electronics module is faulty then try linking that device out (link the +ve cores together) and reinitialising the loop. If the initialisation then passes that point the device

may be replaced. It is not advisable to leave a system with a device missing (positive cores linked together) in this way as all future points will be displaced.

The loop must be re-initialised to clear this fault. Always wait at least 3 minutes between stopping a loop and reinitialising.

Device Faults

If the system detects a **device fault or fire activation** during initialisation, the initialisation will not fail at that point. All devices will be operational (as long as no other faults exist).

However, the system can only ignore a certain amount of fire or fault data until initialisation is complete, and beyond certain limits initialisation will fail and the various fault or fire activations will be displayed.

In either case, the event generated should be dealt with before the loop is reinitialised.

Firstly, investigate and rectify any fire activations which are displayed. These may vary from Manual Call Points which have not been reset, to Multipoint detectors which are contaminated.

Secondly, investigate and rectify any fault conditions which are displayed. These may vary from 'Input open circuit', to a Multipoint detector with its optical chamber loose (indicating signal low).

The system may then be reinitialised and commissioned as required.

Earth Faults

General

If the control panel detects a short circuit to earth/screen from one of its supply rails (either 0v or +ve) an **Earth Fault** will be displayed.

Remove the circuit cables connected to the control panel one at a time and reset the system. When the circuit with the earth fault is disconnected, the earth fault will clear within approximately 30 seconds of being reset.

Note that if a computer is connected to the control panel, an earth fault may be generated at the control panel. If the connection is permanent, an optical isolator must be used between the PC and the control panel.

A short circuit (low resistance: expected to be less than 5R) may be identified and tracked with an electronic test meter between either the positive core or the negative core and the screen of that circuit.

It is not possible to override the earth fault monitoring as it is important for correct system operation.

If it is shown that the earth fault is on the addressable device loop, then disconnect it from the control panel and investigate it with an electronic test meter.

Loop –ve to Screen

If the fault is a **short circuit from screen to loop –ve** then it will be easily identified and rectified with an electronic test meter.

An investigation of the resistance reading between loop –ve and earth/screen at the control panel for each end of the addressable device circuit should give a good indication of the location of the short circuit.

Eg, if the resistance reading at Loop end 1 were 9 ohm, and at Loop end 2 were 3 ohm then it may be estimated that the short circuit lay approximately $9/(3+9) = \frac{3}{4}$ of the way round the addressable device circuit from Loop end 1. Investigating that area, and introducing a split to the Loop –ve as required, will allow it to be tracked and rectified.

Loop +ve to Earth

If the fault is a **short circuit from screen to loop +ve** then it will only be identified with an electronic test meter at that individual length of cable due to the inbuilt short circuit isolators in each device.

To locate this manner of fault, split the +ve core of the loop at approximately a half way point on the loop, then reinitialise with only Loop End 1 connected to the control panel.

Even though the initialisation will fail due to the enforced open circuit, the earth fault will only be indicated if it is located within the section of the cable which was initialised. The split may then be reinstated in another position and the process continued, until the section of the system suspected of containing the earth fault is small enough to allow each portion of cable to be individually tested with an electronic test meter.

General Fault Finding

Common Faults

In the event that inexplicable or random faults continue after any obvious indication has been dealt with, take the following steps.

1. Verify that the addressable device loop cable readings are correct and suitable. Take particular note of the screen resistance and rectify any faults found. Ensure also that there is no connection from the screen to earth in the building other than at the relevant terminals at the control panel.
2. Also check for connection from screen to the building structure which may not be earthed (eg. concrete, plaster, suspended ceilings) as such connections can inject noise into the screen causing communication problems.
3. Ensure the correct number of devices has been initialised by checking at Access Level 3 (Engineer) for the number of devices found on the last initialisation, and compare that with the number of devices programmed onto the system.
4. Ensure that Loop End 1 and Loop End 2 are connected correctly and not running in reverse.
5. Reconfigure the addressable devices using the reconfigure prompt at Access Level 3 (Engineer), then reset the system and test it.
6. Check all devices for loose connections, broken copper connecting strips in the connector, broken connector bodies.

Intermittent and Recurring Faults

Smoke Sensor Failed – Signal High

Ensure that the correct device is being investigated by comparing its description with the device address, and / or the serial number.

Ensure that the Optical Chamber is clean, if not then replace it with a new one and allow it to re-calibrate. See the sections on Self Calibration and Replacing Contaminated Optical Chambers for further details.

If the problem still exists consider changing the electronics module.

Note that the Sita ASD detector has the electronics module and chamber integrated into a single one-piece housing. This unit should be replaced as a complete assembly if either the chamber or electronics module require changing.

Device Faults

If the system detects a **device fault or fire activation** during initialisation, the initialisation will not fail at that point. All devices will be operational (as long as no other faults exist).

However, the system can only ignore a certain amount of fire or fault data until initialisation is complete, and beyond certain limits initialisation will fail and the various fault or fire activations will be displayed.

In either case, the event generated should be dealt with before the loop is reinitialised.

Firstly, investigate and rectify any Fire activations which are displayed. These may vary from Manual Call Points which have not been reset, to Multipoint detectors which are contaminated.

Secondly, investigate and rectify any fault conditions which are displayed. These may vary from 'Input open circuit', to a Multipoint detector with its optical chamber loose (legacy Sita Multipoint only) indicating signal low.

Please note: A short circuit between cores with a value of between 3k and 300 ohm can cause corruption of the data on the loop and although no Short Circuit fault is reported the system integrity will be compromised.

The system may then be reinitialised and commissioned as required.

Device(s) Lost.

If no obvious causes are apparent then replace the device.

Please note: A short circuit between cores with a value of between 3k and 300 ohm can cause corruption of the data on the loop and although no Short Circuit fault is reported the system integrity will be compromised.

Loop Open Circuit

If random or recurrent Loop O/C faults are reported then check the entire system for the following:

Loose connections. Ensure all terminals are reasonably tight.

Broken Connectors. If the terminal is over-tightened the main body of the connector may become broken, causing an intermittent open circuit.

Broken or missing copper connecting strips (Original style Multipoint only – not ASD). The connection from the connector body to the pin which links to the Multipoint detector is made by the copper connecting strip which may be seen entering the connector with the cable. Ensure that these are not broken off or bent out of place as this will cause an intermittent open circuit.

Broken cables. Ensure that the cables are not snapped off before they enter the connector.

A cable may seem to be connected, but not actually make a contact.

Trapped insulation. Ensure that the cable insulation is not trapped in the connector, stopping it from making a connection.

The entire system should be carefully checked for the above, as a cumulative effect may take place if a number of high resistance connections are present, causing random reporting of the location of the problem.

IMPORTANT NOTE

If short circuit or open circuit faults occur on the loop wiring the panel will detect these faults and indicate this with the yellow loop fault LED. These faults will also get logged in the event logs.

The adjacent devices on the loop will open their isolators to isolate the section of cable which is in fault. The panel will use both ends of the loop to communicate with the devices so no devices are lost.

In these cases as no devices are lost the faults may appear to clear but it is most important to check the fault LEDs and event logs on the panel.

When cable faults occur, the loop **MUST BE STOPPED** manually and the faults investigated and rectified before re-initialising the loop again. Do not attempt to rectify a cable fault or to remove and/or reinsert devices into a live loop.

Some loop devices may be lost under certain short circuit, open circuit conditions depending on the nature and position of the fault. Any devices affected will be reported as in fault on the panel.

Note: When the devices open their isolators due to loop faults, the device isolators are latched. The loop MUST BE STOPPED & RE-INITIALISED in order to close the device isolators and reset the devices to a normal operating condition. If this is not done, a second cable fault will result in devices being lost from the addressable circuit. Always wait at least 3 minutes between stopping a loop and reinitialising it.

Summary of Messages

Listed below is a selection of the messages which may be displayed

	MESSAGE	PROMPT	DESCRIPTION
1.	Alarms silenced		The SILENCE ALARMS button has been pressed whilst the sounders were operating, and they have been silenced.
2.	Alarms sounded		The SOUND ALARMS button has been pressed whilst the sounders were not operating, and they have been activated.
3.	AUX input in alarm	Clear the input before resetting the panel	The auxiliary input at a detector or a Loop powered I/O module is in the alarm state. Reset the triggering input to that device before resetting the control panel.
4.	AUX input open circuit	Investigate the input for open circuit	An auxiliary input at a detector or a Loop powered I/O module is in the open circuit state. Check that the 3k3 EOL resistor is fitted, or that the EOL switch is turned on, but not both. Check also that all cables are correctly connected and that the circuit is complete. Note. Even if the auxiliary I/O is set to its output state, it still monitors its input circuit for EOL, and this is still reported as relating to the AUX input.
5.	AUX input short circuit	Investigate the input for short circuit	An auxiliary input at a detector or a Loop powered I/O module is in the short circuit state. Check that the 3k3 EOL resistor is fitted, or that the EOL switch is turned on, but not both. Check also that all cables are correctly connected and that the circuit is complete and not presenting a short circuit to the input. Note. Even if the auxiliary I/O is set to its output state, it still monitors its input circuit for EOL, and this is still reported as relating to the AUX input.
6.	AUX I/O input active	Clear the input before resetting the panel	The auxiliary input at a detector or a Loop powered I/O module is in the alarm state. Reset the triggering input to that device before resetting the control panel.
7.	AUX output short circuit	Investigate the output for short circuit	An auxiliary input at a detector or a Loop powered I/O module is in the short circuit state. Check that the 3k3 EOL resistor is fitted, or that the EOL switch is turned on, but not both. Check also that all cables are correctly connected and that the circuit is complete and not presenting a short circuit to the input. Note. Even if the auxiliary I/O is set to its output state, it still monitors its input circuit for EOL, and this is still reported as relating to the AUX input.
8.	Battery charger failed	Investigate the batteries and charger	A fault has been detected in the battery charger circuitry. Ensure that the battery connections are making a good connection and that the fuse is securely clamped. If possible check the batteries with an intelligent battery tester, or replace them with a new set to see if the fault clears.
9.	Battery failed	Investigate the batteries and fuse	A fault has been detected in the standby batteries. Ensure that the battery connections are making a good connection and that the fuse is securely clamped. If possible check the batteries with an intelligent battery tester, or replace them with a new set to see if the fault clears.
10.	Battery restored		A fault detected in the standby batteries has been cleared.
11.	Battery high resistance		A fault has been detected in the standby batteries and they must be replaced in order to resume correct operation.
12.	Detection head removed	Ensure optical chamber is correctly fitted	The Optical Chamber has been removed from a Multipoint detector.
13.	Device failed	Investigate the device and reinitialise	The device has detected a failure in its processing circuitry or memory and must be replaced.
14.	Device(s) lost	Investigate the device(s) and reinitialise	The device is not reporting to panel on its 'Poll Presence Count'

15.	Earth fault	Remove the s/c to earth	<p>The control panel has detected a short circuit to earth from one of its supply rails (either 0v or +ve).</p> <p>Remove the circuits connected to the control panel one at a time and reset the system. When the circuit with the earth fault is disconnected, the earth fault will clear within approx 30 seconds of being reset.</p> <p>A short circuit (low resistance expected less than 5k) may be identified and tracked with an electronic test meter between either the positive core or the negative core and the screen of that circuit.</p> <p>It is not possible to override the earth fault monitoring as it is important for correct system operation.</p>
16.	Heat sensor failed (OC)	Replace the device	<p>A Multipoint detector has detected an open circuit in its thermistor circuitry.</p> <p>As this circuit is important even for the operation of the smoke detection modes, the device should be replaced.</p>
17.	Heat sensor failed (SC)	Replace the device	<p>A Multipoint detector has detected a short circuit in its thermistor circuitry.</p> <p>As this circuit is important even for the operation of the smoke detection modes, the device should be replaced.</p>
18.	Initialization stopped at device xxx (this message does not appear but the loop initialisation screen stops with a "x" next to the number of the last device initialised)	Investigate the last point initialised	<p>Whilst initialising the addressable device loop, the control panel was unable to sense a complete loop from Loop End 1 returning to Loop End 2.</p> <p>Stop the loop, wait at least 3 minutes and then reinitialise to ensure repeatability, then investigate the last device found (indicated by xxxx) and the following device. If no faults can be found try temporarily linking out that device to see if initialisation will pass that point, thus the device may need replacing.</p>
19.	Loop not initialised	Initialise the loop	<p>The addressable circuit has not been correctly initialised. Check that the number of devices found matches the number of devices on the system.</p>
20.	Loop low resistance	Investigate the loop for short circuit	<p>A low resistance has been detected between the +ve and the -ve core of the addressable device circuit.</p> <p>This has not yet developed into a measurable short circuit, but steps should be taken to rectify the condition before it worsens. Introducing a split into the loop and then initialising from one end only will help to identify the location of the problem.</p>
21.	Loop stopped	Initialise the loop	<p>The addressable device circuit had been stopped and the devices are inactive.</p>
22.	Mains failed	Reinstate the mains supply	<p>The incoming AC supply has been removed.</p> <p>Check the supply voltage of approx 230V AC at the panel AC input terminals, and that the fuses in that circuit are intact.</p>
23.	Node xxx reset	Replace the device	<p>The device has reset itself.</p> <p>Check in the event log to see if it is occurring regularly, and if so change the device.</p>
24.	Open circuit at position xxx	Investigate the loop for +ve open circuit	<p>An open circuit has been detected in the +ve core of the addressable device circuit between the device indicated and the next.</p> <p>Check connections and cable in that area, stop the loop, wait at least 3 minutes and then reinitialise the loop. If it occurs again the device should be changed.</p> <p>Please note that fixing the open circuit without stopping and reinitialising the loop will not clear the fault and will reduce the system's ability to deal with a second open circuit fault elsewhere in the wiring.</p>

25.	Open circuit: in –ve core of loop	Investigate the loop for -ve open circuit	<p>An open circuit has been detected in the -ve core of the addressable device circuit.</p> <p>Stop the loop, wait at least 3 minutes and then reinitialise with one end connected only. The initialisation will then stop at the relevant point.</p> <p>Check connections and cable and reinitialise the loop. If it occurs again, the base/backbox should be changed.</p> <p>Once the loop can be fully initialised without the open circuit being reported, stop the loop, wait at least 3 minutes and then reinitialise with both ends connected as normal.</p> <p>See “Initialisation Faults” for more information.</p>
26.	Open circuit: input xxx	Investigate the input for open circuit	<p>The input is in the open circuit state. Check that the 3k3 EOL resistor is fitted, or that the EOL switch is turned on (loop devices only), but not both. Check also that all cables are correctly connected and that the circuit is complete.</p> <p>Note. Even if the auxiliary I/O is set to its output state, it still monitors its input circuit for EOL, and this is still reported as relating to the AUX input.</p>
27.	Open circuit: output xxx	Investigate the output for open circuit	<p>The output is in the open circuit state. Check that the 10k/3k3 EOL resistor is fitted, or that the EOL switch is turned on (loop devices only), but not both. Check also that all cables are correctly connected and that the circuit is complete.</p>
28.	Smoke sensor failed: signal high	Investigate Optical Chamber for contamination	<p>The current standing optical level (the level of reflection received by the optical receiver within the Multipoint optical chamber, probably caused by contamination) has risen as far as the automatic recalibration of the device can allow, and a replacement optical chamber should be installed. In the case of ASD detectors, which have an integrated chamber, it would be best to replace the detector.</p>
29.	Smoke sensor failed: signal low	Investigate Optical Chamber	<p>The current standing optical level (the level of reflection received by the optical receiver within the Multipoint optical chamber, probably caused by contamination) has fallen as far as the automatic recalibration of the device can allow. Check that the optical chamber is correctly locked in place. If it was then a replacement optical chamber should be installed. If this still does not rectify the problem then a new electronics module should be installed. In the case of ASD detectors, which have an integrated chamber, it would be best to replace the detector.</p>
30.	System fault	Repower and reconfigure system	<p>The control panel has detected a processor or memory fault. The system may be working, but the problem should be dealt with immediately.</p> <p>Power the control panel down to reset the fault, then re initialise and reset before testing for correct operation.</p>
31.	Uninitialised node, address xxx	Investigate the device and reinitialise	<p>A device which was previously initialised, has requested initialisation whilst out of the normal initialisation mode.</p> <p>Either a device has reset and wished to be reinitialised, or a new/replacement device has been connected whilst the loop is still live.</p>
32.	Warning: optical level high	Investigate Optical Chamber for contamination	<p>The current standing optical level (the level of reflection received by the optical receiver within the Multipoint optical chamber, probably caused by contamination) has risen enough to be of concern, and it is suggested that a replacement optical chamber is installed. In the case of ASD detectors, which have an integrated chamber, it would be best to replace the detector.</p>
33.	Warning: optical level low	Investigate Optical Chamber	<p>The current standing optical level (the level of reflection received by the optical receiver within the Multipoint optical chamber, probably caused by contamination) has fallen enough to be of concern. Check that the Optical Chamber is correctly locked in place. If this does not rectify the matter it is suggested that a replacement optical chamber is installed. If this still does not rectify the problem then a new electronics module should be installed. In the case of ASD detectors, which have an integrated chamber, it would be best to replace the detector.</p>

Advanced Connections

Monitored Relays

Monitored Relays

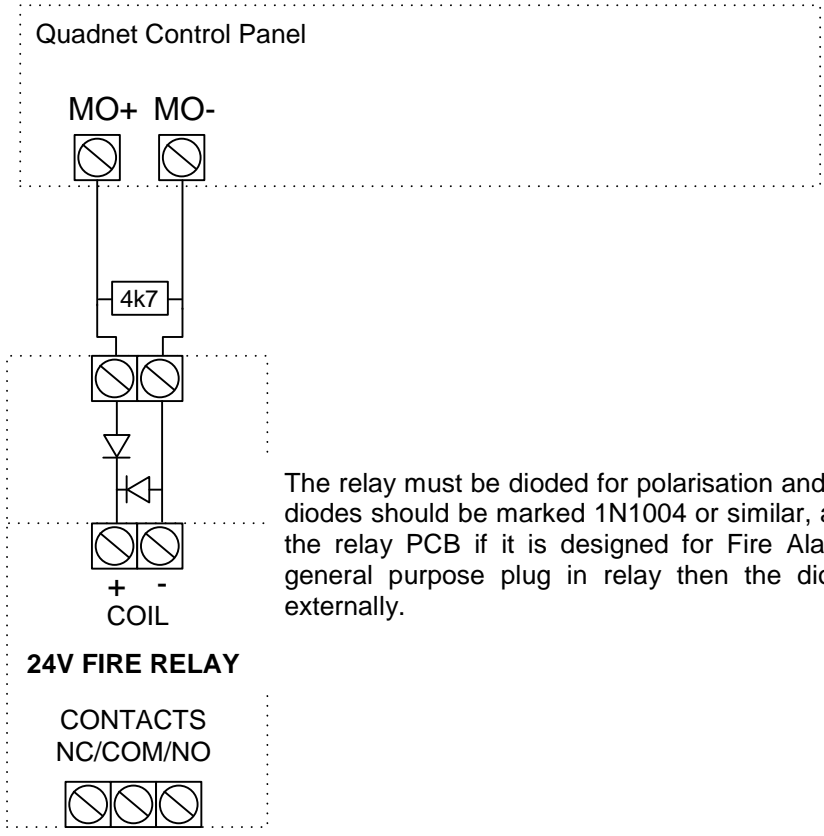

The relay must be dioded for polarisation and suppression as shown. These diodes should be marked 1N1004 or similar, and may already be located on the relay PCB if it is designed for Fire Alarm Systems. If the relay is a general purpose plug in relay then the diodes may need to be added externally.

Technical Data

Control Panel

	Quadnet Control and Indicating Equipment	
Dimensions	W x H x D	445mm x 445mm x 110mm
No. of zones	128 zones	
Number of loops	Up to 4 loops via plug-in loop cards	(1 included as standard with panel)
No of devices	Maximum of 200 devices <i>or</i> maximum of 450 DLUs per loop	(whichever is reached first)
Device labels	31 characters	
LCD display	Graphic display	
	Field 1 (top)	Control Panel Information Window
	Field 2	Active Information Window
	Field 3	Prompt Window
	Field 4 (bottom)	Network Information Window
LED Indication	Fire	Red - steady in fire
	Fault	Yellow - intermittent (0.3s On, 2.1s off) - pulsed (0.3s On, 0.5s off)
	Disabled	Yellow - continuous
	Test	Yellow - pulsed (0.3s on, 0.5s off)
	Power	Green - continuous for power on
Audible Indication	2.5kHz Buzzer	Continuous in fire Intermittent (0.3s on, 2.1s off) in fault
Keypad	4 way dedicated 17 way alphanumeric	Fire Alarm Controls System Controls
Event log	1000 events	
Inputs and Outputs	Relay Outputs x 4	Volt free contacts SPCO 30V DC @ 1A max per contact
	Monitored Outputs x 2	2 x 24V conventional monitored outputs Fire, Fault, Signal, Technical Alarm 10k EOL, 200mA max per circuit
	Monitored Inputs x 4	4 x resistance monitored inputs 3k3 EOL, 680R firing resistor
Auxiliary Power Output	Working Range	20 – 31V DC
Power Supply	Working Range	22.5 – 32V DC
Nominal Loop Operating Voltage	40V DC	
Max loop current	500 mA	
Response Times	First fire alarm event	1s
	New zone in alarm	<10s
	Activate 32 alarm zones	3s 1s
	+ve O/C detection	<10s
	-ve O/C detection	<35s
	spur O/C detection	<35s
	Missing device detection	
Environmental Data	IP Rating 30	Ambient Temp Range +5°C to +40°C

Note: Refer to the relevant sections in the manual for full details of input and output ratings

Power Supply Unit

See the Quadnet Power Supply Unit Manual for technical details.

System Version Compatibility

The following table explains the compatibility of the various versions of the Duonet system:

		CONTROL PANEL VERSION					
		V1.00	V2.00	V3.00			
DEVICES							
Multipoint		V1.00	V2.00	V3.00			
Multipoint with sounder		V1.00	V2.00	V3.00			
Manual Call Point		V1.00	V2.00	V3.00			
Manual Call Point with sounder		V1.00	V2.00	V3.00			
Sounder / Soundpoint / Hipoint / Bell		V1.00	V2.00	V3.00			
Flashpoint / Sounder Strobe / Strobe		V1.00	V2.00	V3.00			
Multipoint I/O Interface Module		V1.00	V2.00	V3.00			
Loop Powered I/O Module		V1.00	V2.00	V3.00			
Conventional Zone Interface Module		V1.00	V2.00	V3.00			
FEATURES							
Zonal Cause & Effect		V1.00	V2.00	V3.00			
Point to point Cause & Effect			V2.00	V3.00			
Alarm Confirmation - Local Device warning		V1.00	V2.00	V3.00			
Alarm Confirmation - Zonal Warning		V1.00	V2.00	V3.00			
Alarm Confirmation - Display Option		V1.00	V2.00	V3.00			
Alarm Confirmation - Zonal Linkage		V1.00	V2.00	V3.00			
1-4 loop plug on expansion		V1.00	V2.00	V3.00			
Network		V1.00	V2.00	V3.00			
Site Upgradeable firmware		V1.00	V2.00	V3.00			
View / Edit full device attributes at control panel		V1.00	V2.00	V3.00			

OSP Version Compatibility

The following table explains the compatibility of the various versions of the Duonet system:

		RECOMMENDED OSP VERSION					
		V0.367	V2.04	V3.02			
PANEL VERSION							
Panel Versions up to v1.29		√					
Panel Versions v1.34 to v2.xx			√				
Panel Versions v3.xx				√			

NOTE: It is imperative that the correct version of OSP is used to match your version of Quadnet control panel. The use of an incompatible version may result in incorrect operation of the control panel. In particular, do not use a V2.xx series OSP with a V3.xx series control panel and do not use a V3.xx series OSP with a V2.xx series control panel.

Resistor Colour Codes

On colour coded resistors the band at one end will be spaced further apart than the others. The resistor should be viewed with this band to the right as follows, reading from the left and side of the resistor:

Band	4 Band Codes	5 Band Codes
1	1 st Digit	1 st Digit
2	2 nd Digit	2 nd Digit
3	Multiplier	3 rd Digit
4	Tolerance	Multiplier
5	-	Tolerance

Colour	Digit	Multiplier
Black	0	1
Brown	1	10
Red	2	100
Orange	3	1,000
Yellow	4	10,000
Green	5	100,000
Blue	6	1,000,000
Violet	7	-
Grey	8	-
White	9	-
Gold	-	0.1
Silver	-	0.001

Battery Calculations

Note: An Excel spreadsheet (document no. 26-1049) is also available to automatically work out both standby battery calculations and loop loading calculations based on the quantities entered. This includes ratings for legacy devices as well as the current models listed below.

Current draw ratings for the control panel and current models of devices as at October 2011 are as follows:

PRODUCT DESCRIPTION		QUANTITY	CURRENT DRAWN (mA)		TOTAL (mA)	
Product Code	Description		IS	IA	IS	IA
510 0001	Quadnet Control Panel	1	52.000	111.000	52.000	111.000
	Power Supply Unit		10.000	10.000		
	Loop Card		40.000	40.000		
	Network Card		22.000	22.000		
	Output 5 (MO5) (MAX 200mA) depending on external load IF USED		N/A	200.000	N/A	
	Output 6 (MO6) (MAX 200mA) depending on external load IF USED		N/A	200.000	N/A	
	Aux 24VDC (MAX 200mA) depending on external load IF USED		200.000	200.000		
203 0003	Multipoint Mk3 (from 25/11/09)		0.119	1.985		
205 0003	ASD Mk3		0.115	1.996		
203 0001	Multipoint with Sounder Mk3 SP0 - OFF		0.119	1.994		
	Multipoint with Sounder Mk3 SP3 - LOW		0.119	3.013		
	Multipoint with Sounder Mk3 SP3 - MED		0.119	8.367		
	Multipoint with Sounder Mk3 SP3 - HIGH		0.119	12.035		
205 0001	ASD Mk3 with Sounder SP0 - OFF		0.115	2.071		
	ASD Mk3 with Sounder SP3 - LOW		0.115	3.090		
	ASD Mk3 with Sounder SP3 - MED		0.115	8.385		
	ASD Mk3 with Sounder SP3 - HIGH		0.115	12.167		
205 0012	ASD with Sounder/Strobe Mk3 SP0 - OFF		0.115	8.321		
	ASD with Sounder/Strobe Mk3 SP3 - LOW		0.115	9.340		
	ASD with Sounder/Strobe Mk3 SP3 - MED		0.115	14.635		
	ASD with Sounder/Strobe Mk3 SP3 - HIGH		0.115	18.421		
403 0006 403 0007	Manual Call Point Mk3		0.173	5.954		
313 0001 313 0002 313 0003	Soundpoint Mk3 SP3 - OFF		0.172	2.663		
	Soundpoint Mk3 SP3 - LOW		0.172	3.615		
	Soundpoint Mk3 SP3 - MED		0.172	8.046		
	Soundpoint Mk3 SP3 - HIGH		0.172	11.219		
323 0001	Hipoint Mk3 SP3 - OFF		0.176	2.090		
	Hipoint Mk3 SP3 - LOW		0.176	3.590		
	Hipoint Mk3 SP3 - MED		0.176	7.988		
	Hipoint Mk3 SP3 - HIGH		0.176	11.158		
303 0013	Bell Mk2 – OFF		0.185	3.192		
	Bell Mk2 – LOW/MED/HIGH		0.185	46.231		
303 0012 303 0022	Flashpoint SP0 - OFF		0.467	2.365		
	Flashpoint SP3 - LOW		0.467	9.306		
	Flashpoint SP3 - MED		0.467	13.490		
	Flashpoint SP3 - HIGH		0.467	16.096		
326 0021 326 0023	Sounder/Strobe SP0 - OFF		0.172	18.750		
	Sounder/Strobe SP3 - LOW		0.172	19.792		
	Sounder/Strobe SP3 - MED		0.172	23.958		
	Sounder/Strobe SP3 - HIGH		0.172	28.125		
326 0001 326 0003	Sounder SP0 - OFF		0.172	2.740		
	Sounder SP3 - LOW		0.172	3.615		
	Sounder SP3 - MED		0.172	8.042		
	Sounder SP3 - HIGH		0.172	11.183		
326 0015	Strobe SP0 - OFF		0.172	18.750		
803 0006	Loop I/O Module Mk2		0.461	21.058		
803 0010	Conventional Zone Module (Loop Powered)		11.222	48.754		
	Conventional Zone Module (Ext PSU)		0.402	7.088		
803 0005 803 0003	Multipoint I/O Module (Box or Relay Base)		0.030	6.388		
600 0092	Remote Indicator		N/A	1.042	N/A	

TOTALS

TIMES

CURRENT REQUIRED (mAH)

TOTAL CURRENT (mAH)

TOTAL CURRENT (Ah)

BATTERY REQUIREMENT (Ah)

ISTOT (mA) A		IATOT (mA) B	
STANDBY (Hrs) C		ALARM (Hrs) D	
IS A x C (mAH) E		IA B x D (mAH) F	
		E + F = G	
		G / 1000 = H	
		H x 1.25 = J	

Installation Checklist

Use the following checklist to ensure that your work is correct and that the commissioning engineer has the necessary information to complete the commissioning of the system

The commissioning engineer will require this sheet, along with 'Loop Continuity and Insulation Test Results', correctly marked 'as-wired' drawings and completed 'Configuration sheets', before attending site to commission the system.

Stage 1

Description	Loop Checked by Installation Engineer				Loop Checked by Commissioning Engineer			
	1	2	3	4	1	2	3	4
Loop cable installed correctly, clipped or in containment.								
All loop bases and back boxes installed and terminated.								
All devices have positive core links in place.								
Loop insulation and continuity testing complete, and form filled out.								
As-wired drawing marked up showing cable runs and devices.								
Configuration sheets completed with devices descriptions etc.								
Control Panel backbox installed with 230V AC supply live, tested and isolated locally								

Stage 2

Depending on the terms of your contract, you may also be required to carry out 'Stage 2'.

Description	Loop Checked by Installation Engineer				Loop Checked by Commissioning Engineer			
	1	2	3	4	1	2	3	4
Devices installed into bases and backboxes								
Detector dust covers fitted								
Serial numbers noted on drawings and 'Configuration Sheets'								

Site Name & Address:	
Installation Company:	
Testing Engineer:	
Signature:	
Date:	

Commissioning Checklist

The following checklist may be used to ensure that all steps are taken. It serves as a reminder only and may need additional items added if required.

Step 1

Description	Checked by Commissioning Engineer			
	LOOP 1	LOOP 2	LOOP 3	LOOP 4
Low voltage test meter shows 0v and earth continuity, and no inter-core short circuits. (+ve core will only have continuity if link pins fitted instead of devices. One device installed and initialised satisfactorily.				
Remainder of devices installed and initialised in sections until entire system is initialised satisfactorily.				
All faults (device, input, output, EOL, battery, etc.) cleared from control panel.				
Correct operation and device poll verified using Sita DIAGNOSTIC				

Step 2

Data Uploaded to PC				
Configuration set up on PC				
Data downloaded to control panel				
Addressable loop reconfigured.				
System Reset				
All ancillary inputs and outputs connected and faults cleared				

Step 3

Correct operation of all input devices tested, ie, detectors, manual call points and inputs.				
Correct operation of all output devices tested, ie, sounders, relays and outputs				
Correct operation of all programmed actions tested, ie, instant, delays, confirmation alarms, multi-stages				

Step 4

System Manuals completed, zone chart or zone list displayed.				
End user or responsible person trained and user manual issued.				

Site Name & Address:	
Commissioning Company:	
Commissioning Engineer:	
Signature:	
Date:	

Loop Continuity and Insulation Test Results

After installation of the cable, and termination into all the relevant back-boxes, ensure that the link pins are installed as necessary in order to be able to take cable continuity and insulation readings. Make sure that all the cables are dressed smoothly and neatly into their back-boxes in order that they will not be disturbed after the readings are taken.

The commissioning engineer will require these readings, along with correctly marked 'as-wired' drawings and completed configuration sheets, before attending site to commission the system.

CORE	CONTINUITY READING (OHMS)			
	LOOP 1	LOOP 2	LOOP 3	LOOP 4
LE1 +ve to LE2 +ve				
LE1 -ve to LE2 -ve				
LE1 Scrn to LE2 Scrn				

A reading of approximately 1.2 ohm per 100 metres of 1.5 mm² cable is expected and any significant variation from this should be investigated. If the above readings are satisfactorily showing circuit continuity then you may also take the reading below.

CORE	CONTINUITY READING (OHMS)			
	LOOP 1	LOOP 2	LOOP 3	LOOP 4
+ve to -ve				
+ve to Screen				
-ve to Screen				
Loop Screen to Mains Earth				

No continuity between cores should be seen and a reading of OL should be shown on the test meter. Any significant variation from this should be investigated. If the readings are satisfactory then the loop wiring is largely proven other than for faults such as complete polarity reversal.

Site Name & Address:	
Installation Company:	
Testing Engineer:	
Signature:	
Date:	

Network Continuity & Insulation Test Results

After installation of the cable, and termination into all the relevant back-boxes, take cable continuity and insulation readings. Make sure that all the cables are dressed smoothly and neatly into their back-boxes in order that they will not be disturbed after the readings are taken.

The commissioning engineer will require these readings, along with correctly marked 'as-wired' drawings and completed configuration sheets, before attending site to commission the system.

CORE	CONTINUITY READING (OHMS)			
	<i>Main Ring</i>			
+ve to +ve				
-ve to -ve				
Screen to Screen				

A reading of approximately 1.2 ohm per 100 metres of 1.5 mm² cable is expected and any significant variation from this should be investigated. If the above readings are satisfactorily showing circuit continuity then you may also take the reading below.

CORE	INSULATION READING (OHMS)			
	<i>Main Ring</i>			
+ve to -ve				
+ve to Screen				
-ve to Screen				
Screen to Mains Earth				

No continuity should be seen between cores and a reading of OL should be shown on the test meter. Any significant variation from this should be investigated. If the readings are satisfactory then the loop wiring is largely proven other than for faults such as complete polarity reversal.

Site Name & Address:	
Installation Company:	
Testing Engineer:	
Signature:	
Date:	

FIRE ALARM SYSTEM NOTICE

To Enable the Control Panel Keys

The user controls are accessed from Access Level 2 (User) which is reached as follows:

Enter your access code, eg 1234, followed by **enter**, or insert the key and turn it clockwise.

The Enable Controls light will switch on, you are now in Access Level 2 (User) and you may proceed to silence and reset the system.

To prevent unauthorised operation the controls should be kept disabled and the code / key kept secure under the control of the responsible person

To Manually Operate the Fire Alarm Sounders

To sound the alarms press the **SOUND ALARMS** button at Access Level 2 (User) as above.

Following a Detector or Manual Call Point Operation

The **FIRE** LED will illuminate, the fire alarm sounders and the internal panel buzzer will operate as programmed. Take appropriate action as defined by the emergency plan for the premises.

To silence the alarms press the **SILENCE ALARMS** button at Access Level 2 (User) as above, then establish the cause of the alarm and enter the details in the log book.

Reset any Manual Call Points which may have been operated, or if a detector has been operated be sure that the cause of the alarm has been removed, before resetting the system by pressing the **RESET SYSTEM]** button at Access Level 2 (User) as above.

Following a Fault Condition

The appropriate fault LEDs will illuminate. The internal panel buzzer will sound. To mute the internal panel buzzer, press the **SILENCE BUZZER** button at Access Level 2 (User) as above. Investigate and rectify the appropriate fault (competent persons).

To Test the Indication LEDs

Select the **Test Display** prompt with the **UP / DOWN** keys, then press **ENTER** at Access Level 2 (User).

To Disable the Control Panel Keys

When finished with the controls above, press the **ESC** button, or **turn the key off and remove it**. The system will return to Access level 1 (Normal)

The controls enabled light will have switched off and the controls will be disabled.

Important Notes

It is a requirement of the **Workplace Regulations** that your Fire Alarm System must be regularly serviced by competent persons.

FIRE ALARM COMPANY: _____
ADDRESS: _____
For service phone: _____ (Working hours) _____ (Out of working hours)

CONTROL PANEL INSTRUCTION NOTICE

FIRE ALARM SYSTEM NOTICE

Note

The Fire alarm system installed in this building utilises 'Alarm Confirmation' technology to help eliminate false alarms.

Please read and understand the following information in order to make the most effective use of the system.

Operation

When the detector within your area activates it will initially only operate the sounders within your own area for a predetermined 'Alarm Confirmation' time.

At the end of the 'Alarm Confirmation' time the system will check the detector again to see if the activation has cleared. If so then the sounders will silence and no further action need be taken.

If, however, the detector is still activated then the entire system will go into alarm, operating all the sounders on the system.

Action Required

If you think that you may have accidentally set off the fire alarms then check the following:

If the fire alarm sounders within your area only are operating, then check your own area for the cause of the alarm. If this proves to be a false alarm due to dust, cooking fumes, steam, cigarette smoke, etc, then clear the smoke from the area in order to allow the system to reset itself after a few minutes. If this happens then no further action is required.

If you discover a genuine fire, or the fire alarm sounders in the communal areas are also operating, then follow the buildings fire procedures for evacuation, activating the nearest Fire Alarm manual call point on the way out.

Do not attempt to put out the fire unless it is safe to do so.

Further Information

Further information will be located adjacent to the Main Fire Alarm Control Panel, or may be obtained from either the person responsible for building maintenance or from the Fire Alarm Company responsible for maintaining the Fire Alarm System.

Your Notes

Your Notes

Your Notes

Important Points

- Use a **2-core 1.5mm² with screen fire rated cable** as per the specifications in “Cable Specification” and “Network Cable Specification”.
- For each loop, connect all the devices in a complete **loop** (returning from the last device to the control panel).
- Make sure that the cable screens are sleeved, connected together and connected to **the relevant connections at the control panel**.
- Leave a copy of the User Instructions by the control panel, and make sure that you have explained its operation carefully to the relevant persons (the user, not the contractors or their agents).
- Do not remove devices or chambers in earlier devices with the loop active – this could cause the system to go into full fire.

If you have any further queries, please contact your supplier for further information

Technical Support

Contact your distributor for technical support on this product.

Do not call the Fike Safety Technology technical support department unless your distributor has first given their advice and attempted to rectify the issue.

Technical support will not be available if the instruction manual has not been read and understood. Please have this instruction manual available whenever you call for technical support.

 0832	
Fike Safety Technology Ltd Unit 31, Springvale Ind. Est. Torfaen, NP44 5BD 12 DoP-507-0001, DoP-507-0009	
EN54-2: 1997 +A1: 2006, EN54-4: 1997 +A1: 2002 +A2: 2006 507-0001 Intended for use in the fire detection and fire alarm Systems in and around buildings	
Essential characteristics	Performance
Operational reliability	Pass
Durability of operational reliability and response delay, Temperature resistance	Pass
Durability of operational reliability, Vibration resistance	Pass
Durability of operational reliability, Humidity resistance	Pass
Durability of operational reliability, Corrosion resistance	Pass
Durability of operational reliability, Electrical stability	Pass
Performance under fire conditions	Pass
Response delay (response time to fire)	Pass
Performance of power supply	Pass